



INSTRUCTION MANUAL

**Types 1863 and 1864
Megohmmeters**

B

GENERAL RADIO

Contents

CONDENSED OPERATING INSTRUCTIONS
SPECIFICATIONS
INTRODUCTION – SECTION 1
INSTALLATION – SECTION 2
OPERATION – SECTION 3
THEORY – SECTION 4
SERVICE AND MAINTENANCE – SECTION 5
PARTS LISTS AND DIAGRAMS – SECTION 6

Types 1863 and 1864 Megohmmeters

B

©GENERAL RADIO COMPANY 1969

Concord, Massachusetts, U.S.A. 01742

Form 1863-0100-B

March, 1973

ID-1863-0100

ID-1864-4368

WARRANTY

We warrant that this product is free from defects in material and workmanship and, properly used, will perform in full accordance with applicable specifications. If, within a period of ten years after original shipment, it is found, after examination by us or our authorized representative, not to meet this standard, it will be repaired or, at our option, replaced as follows:

- No charge for parts, labor or transportation during the first three months after original shipment;
- No charge for parts or labor during the fourth through the twelfth month after original shipment for a product returned to a GR service facility;
- No charge for parts during the second year after original shipment for a product returned to a GR service facility;
- During the third through the tenth year after original shipment, and as long thereafter as parts are available, we will maintain our repair capability and it will be available at our then prevailing schedule of charges for a product returned to a GR service facility.

This warranty shall not apply to any product or part thereof which has been subject to accident, negligence, alteration, abuse or misuse; nor to any parts or components that have given normal service. This warranty is expressly in lieu of and excludes all other warranties expressed or implied, including the warranties of merchantability and fitness for a particular purpose, and all other obligations or liabilities on our part, including liability for consequential damages resulting from product failure or other causes. No person, firm or corporation is authorized to assume for us any other liability in connection with the sale of any product.

Condensed Operating Instructions

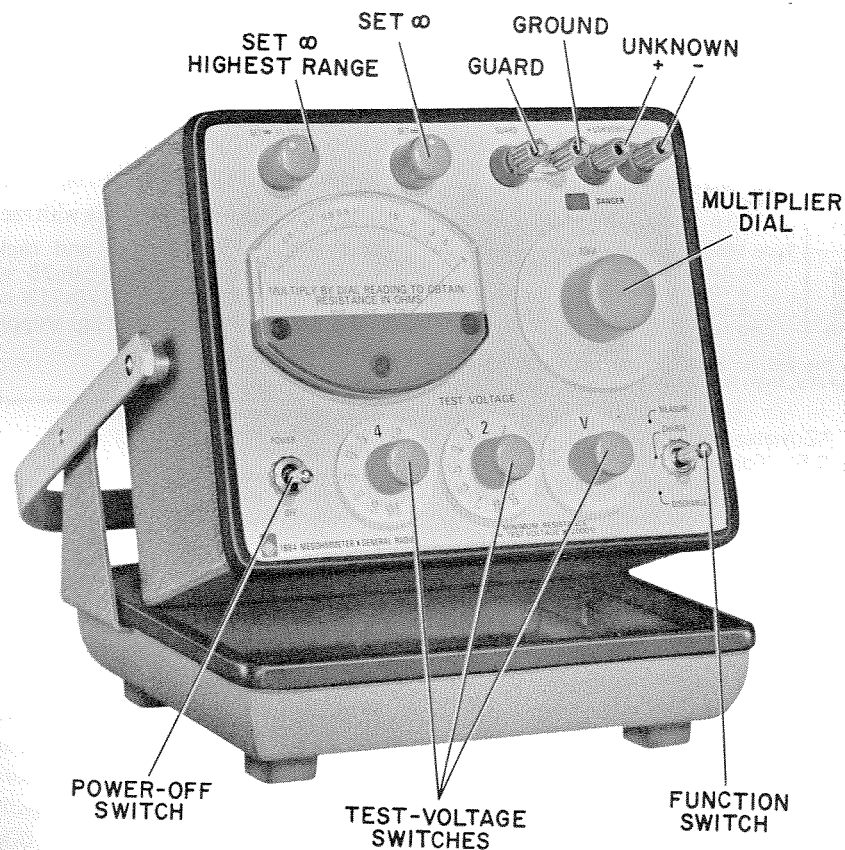

Figure 1-1. Type 1864 front-panel view.

NOTE

The 1863 front panel is similar. See Figure 1-2.

- Determine which ground link connection is to be used (paragraph 3.1.1).
- Set the TEST VOLTAGE switch(es) to the proper voltage (paragraph 3.1.2).
- Set the ∞ adjustments (paragraph 3.1.3).
- Connect the unknown to the UNKNOWN terminals.
- Measure the unknown with either the search (paragraph 3.2.2) or sort (paragraph 3.2.3) procedure.

Specifications

Voltage and Resistance Ranges:

Voltage	R_{min} Full Scale	10% of Scale	$R_{max}†$ 2½% of Scale	Useful Ranges
50, 100 V 200, 250, 500 V	50 kΩ 500 kΩ	Type 1863 500 GΩ 5 TΩ	2 TΩ 20 TΩ	7 7
10 to 50 V 50 to 100 V 100 to 500 V 500 to 1090 V	50 kΩ 200 kΩ 500 kΩ 5 MΩ	Type 1864 500 GΩ 5 TΩ 5 TΩ 50 TΩ	2 TΩ* 20 TΩ 20 TΩ* 200 TΩ	7* 8 7* 8

† Note: Meter deflects to the left, so 2½% is near the right; however, the meter scale reads naturally, from left to right.

* Recommended limit.

Resistance Accuracy: $\pm 2(\text{meter reading} + 1)\%$ on lowest 5 ranges (min reading is 0.5). For 6th, 7th, 8th ranges, respectively, add $\pm 2\%$, $\pm 4\%$, $\pm 5\%$, for the 1863; $\pm 2\%$, $\pm 3\%$, $\pm 5\%$, for the 1864.

Voltage Accuracy (across unknown): $\pm 2\%$.

Short-Circuit Current: 5 mA approx.

Power: 100 to 125 or 200 to 250 V, 50 to 400 Hz, 13 W.

Supplied: Mounting hardware with rack models.

Mechanical: Flip-Tilt case and rack mount. DIMENSIONS (wxhxd): Portable, 6.63x10x6.75 in. (245x254x172 mm); rack, 19x7x4.63 in. (483x178x118 mm). WEIGHT: Portable, 9.5 lb (4.4 kg) net, 14 lb (7 kg) shipping; rack 11 lb (5 kg) net.

Description	Catalog Number
1863 Megohmmeter	
Portable Model	1863-9700
Rack Model	1863-9701
1864 Megohmmeter	
Portable Model	1864-9700
Rack Model	1864-9701

GR Experimenter Reference, March-April, 1969. U.S. Patent No. D 187,740 and 2,966,257.

Introduction—Section 1

1.1 DESCRIPTION	1-1
1.2 OPENING AND TILTING THE CABINET	1-1
1.3 CONTROLS, CONNECTORS AND INDICATORS	1-1
1.4 ACCESSORIES SUPPLIED	1-1
1.5 ACCESSORIES AVAILABLE	1-1
1.6 SYMBOLS	1-5
1.7 CONNECTIONS	1-5

WARNING

High voltage is applied to the measurement terminals of the Types 1863 and 1864 Megohmmeters, except when the function switch is set to DISCHARGE. While the current from the instrument is limited to a value that is not dangerous under most conditions, the energy stored in a capacitor connected to the terminals may be lethal. Always set the function switch to DISCHARGE when you connect or disconnect the unknown.

1.1 DESCRIPTION.

The Type 1863 Megohmmeter indicates directly on the panel meter any resistance from 0.5 to 20,000,000 M Ω ; the Type 1864 (Figure 1-1) indicates resistance from 0.5 to 200,000,000 M Ω . These ranges are suitable for leakage-resistance measurements of most types of insulation used in electrical machinery, electronic devices and components, etc (Section 4). The voltage applied to the unknown can be 50, 100, 200, 250 or 500 V from the 1863, as selected by the TEST VOLTAGE switch on the front panel. The 1864 has a voltage range from 10 to 1090 V that can be set in 1-V steps from 10 to 109 V, and 10-V steps from 100 to 1090 V by the TEST VOLTAGE switch on the front panel.

The 100-volt level is the EIA standard for measurement of composition, film, and wire-wound resistors above 100 kilohms. The 500-volt level is a standard value in the measurement of the insulation resistance of rotating machinery, transformers, cables, capacitors, appliances, and other electrical equipment.

Regulated power supply and charging circuit permit rapid and accurate measurement of the leakage resistance of capacitors.

Guard and ground terminals permit measurement of grounded or ungrounded two-or three-terminal resistors.

A panel warning light indicates when voltage is applied to the test terminals and thus permits connections to be made safely.

1.2 OPENING AND TILTING THE CABINET.

The Flip-Tilt cabinet can be opened by placing the instrument on its rubber feet with the handle away from you. Push down on the handle and the instrument, located in the upper part of the case, will rotate to a vertical position. While holding the handle down with one hand, rotate the instrument to the desired position with the other hand and release the handle.

1.3 CONTROLS, CONNECTORS AND INDICATORS.

Figure 1-2 shows the front-panel controls, connectors and indicators of the 1863 and 1864. Table 1-1 lists and identifies them. Figure 1-3 shows the rear panel controls and connectors and Table 1-2 lists and identifies them.

1.4 ACCESSORIES SUPPLIED.

The accessories supplied with the 1863 and 1864 Megohmmeters are listed in Table 1-3.

1.5 ACCESSORIES AVAILABLE.

Table 1-4 lists a group of GR patch cords available for use with the megohmmeters. The GR 1591 Variac® Automatic Voltage Regulator can be used with the megohmmeters (paragraph 4.3.5 part 3). Consult the latest GR Catalog for a complete selection of accessories.

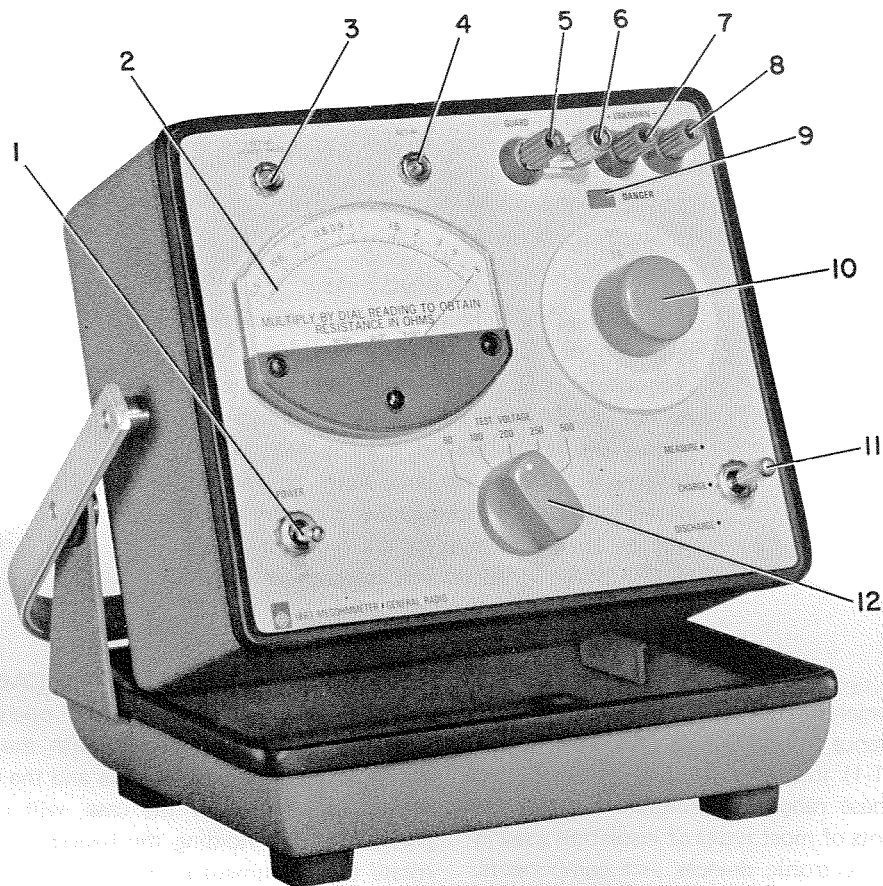

Figure 1-2. Type 1863 front-panel controls, connectors and indicators.

NOTE

The 1864 front panel is similar. See Figure 1-1.

Table 1-1
FRONT-PANEL CONTROLS, CONNECTORS AND INDICATORS

Figure 1-2 Reference	Name	Instrument		Type	Function
		1863	1864		
1	POWER OFF	X	X	2-position toggle switch	Turns power on and off.
2	Meter	X	X	4-in. meter with plastic cover	Indicates the value to be multiplied by the multiplier switch.
3	SET ∞ HIGHEST RANGE	X		Screwdriver rotated control	Adjusts high end of meter scale on highest resistance range to compensate for offset current.
			X	Knob rotated control	
4	SET ∞	X		Screwdriver rotated control	Adjusts high end of meter scale to compensate for offset voltage in the voltmeter.
			X	Knob rotated control	
5	GUARD	X	X	Insulated binding post	For guarded measurements. The center of the post is 3/4 in. from the center of the ground post so that it can accept a shorting link.
6	Ground	X	X	Uninsulated binding post	Grounds the + unknown or guard. Contains captive shorting link.
7	UNKNOWN +	X	X	Insulated binding post	Connects the + side of the unknown to the megohmmeter.
8	UNKNOWN -	X	X	Insulated binding post	Connects the - side of the unknown to the megohmmeter.
9	DANGER	X	X	Indicating light shaded red	Glows red when the function switch is in the CHARGE or MEASURE position.
10	Multiplier	X		7-position rotary switch	Selects resistance range.
			X	8-position rotary switch	
11	MEASURE- CHARGE- DISCHARGE	X	X	3-position toggle switch	Selects the operating mode applied to the unknown.
12	TEST VOLTAGE	X		5-position rotary switch	Selects the test voltage as 50, 100, 200, 250 or 500 V.
			X	3 rotary switches: a 10- position, a 9-position and a 2-position (left to right)	Select voltage in 1-V steps from 10 to 109 V and in 10-V steps from 100 to 1090 V.

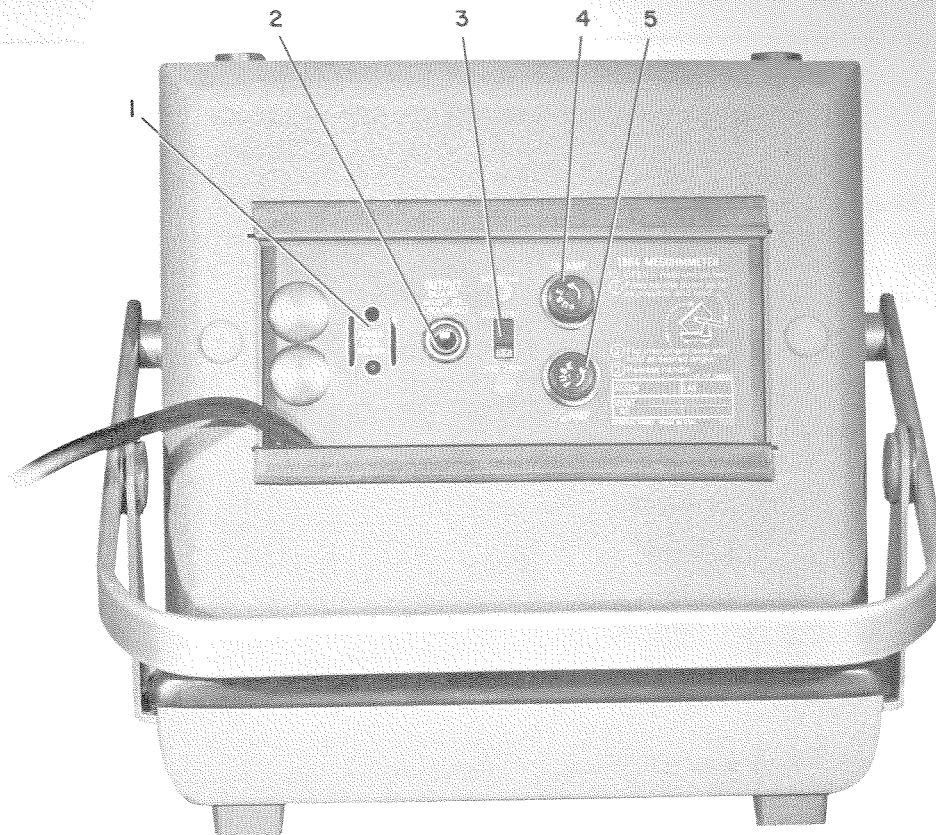

Figure 1-3. Type 1864 rear-panel controls and connectors.

Table 1-2
REAR-PANEL CONTROLS AND CONNECTORS

Figure 1-3 Reference	Name	Instrument		Type	Function
		1863	1864		
1	POWER PLUG HOLDER	X	X	Holes cut in rear panel	Holds power plug in place after power cord has been wrapped inside cover.
2	OUTPUT	X	X	Phone jack (Accepts Switchcraft No. 440 phone plug)	Provides a dc voltage output for recorder operation.
3	Line-voltage	X	X	2-position slide switch	Connects wiring of power transformer for either 100- to 125-V or 200- to 230-V input.
4	1/8 AMP	X	X	Extractor-type fuse holder	Holder for 1/8-A fuse for 100- to 125-V operation.
5	1/16 AMP	X	X	Extractor-type fuse holder	Holder for 1/16-A fuse for 200- to 230-V operation.

Table 1-3
ACCESSORIES SUPPLIED*

Item	GR Part Number	Quantity
Instruction Manual	1863-0100	1

*Supplied with either an 1863 or 1864 or Megohmmeter, portable or rack-mount instrument.

1.6 SYMBOLS.

These instruments indicate the resistance of the unknown in multiples of ohms. The relationship between ohms (Ω), kilohms ($k\Omega$), megohms ($M\Omega$), gigaohms ($G\Omega$), and teraohms ($T\Omega$) is as follows:

$$1 M\Omega = 10^6 \Omega = 10^3 k\Omega$$

$$1 G\Omega = 10^9 \Omega = 10^6 k\Omega = 10^3 M\Omega$$

$$1 T\Omega = 10^{12} \Omega = 10^9 k\Omega = 10^6 M\Omega = 10^3 G\Omega$$

1.7 CONNECTIONS.

The UNKNOWN, GUARD and ground terminals are standard 3/4-in. spaced binding posts that accept banana

plugs, standard telephone tips, alligator clips, crocodile clips, spade terminals and all wire sizes up to number eleven (Figure 1-4).

When several measurements of components with leads are to be made, the GR 1650-P1 Test Jig (Figure 1-5) can be used.

WARNING

The terminals of the test jig are not insulated. The presence of a high test voltage can be dangerous.

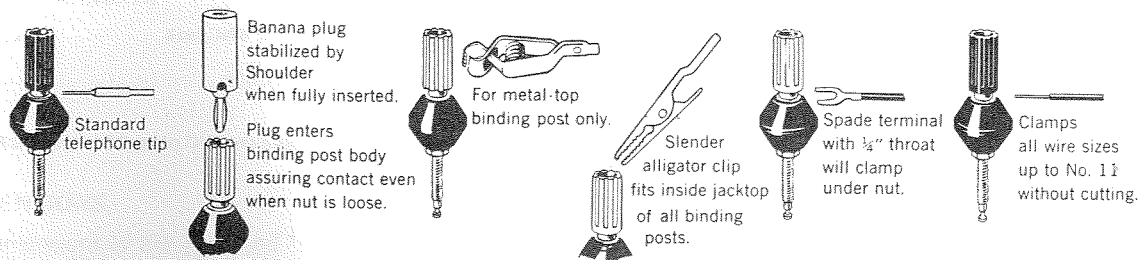

Figure 1-4. Methods of connection to the measurement terminals.

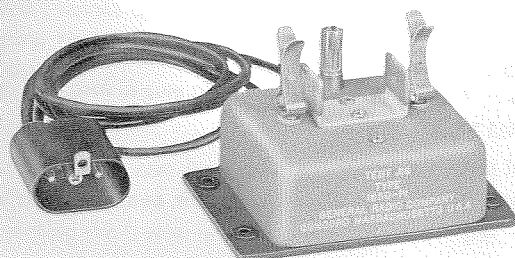

Figure 1-5. Type 1650-P1 Test Jig.

Table 1-4
AVAILABLE INTERCONNECTION ACCESSORIES

TYPE NO.	DESCRIPTION	CATALOG NO.
274-NQ 274-NQM 274-NQS	Double-plug patch cord, in-line 36" long Double-plug patch cord, in-line 24" long Double-plug patch cord, in-line 12" long	0274-9860 0274-9896 0274-9861
274-NP 274-NPM 274-NPS	Double-plug patch cord, right-angle 36" long Double-plug patch cord, right-angle 24" long Double-plug patch cord, right-angle 12" long	0274-9880 0274-9892 0274-9852
274-NL 274-NLM 274-NLS	Shielded double-plug patch cord, 36" long Shielded double-plug patch cord, 24" long Shielded double-plug patch cord, 12" long	0274-9883 0274-9882 0274-9862
274-LLB 274-LLR 274-LMB 274-LMR 274-LSB 274-LSR	Single-plug patch cord, black, 36" long Single-plug patch cord, red, 36" long Single-plug patch cord, black, 24" long Single-plug patch cord, red, 24" long Single-plug patch cord, black, 12" long Single-plug patch cord, red, 12" long	0274-9468 0274-9492 0274-9847 0274-9848 0274-9849 0274-9850
1560-P95	Adaptor cable, double-plug to telephone plug, 36"	1560-9695
874-R34	Coaxial patch cord, double plug to GR874, 36" long	0874-9692
874-R33	Coaxial patch cord, two plugs to GR874, 36" long	0874-9690
274-QBJ	Adaptor, shielded double plug to BNC jack	0274-9884
776-A	Patch cord, shielded double plug to BNC plug, 36" long	0776-9701
874-R22A	Coaxial patch cord GR874 to GR874, 36" long	0874-9682
776-B	Patch cord, GR874 (right-angle) to BNC plug, 36" long	0776-9702
776-C	Patch cord, BNC plug to BNC plug, 36" long	0776-9703
776-D	GR874 to GR874, both right-angle, 36" long	0776-9704

274-13XA

Installation—Section 2

2.1 DIMENSIONS	2-1
2.2 BENCH MOUNTING	2-1
2.3 POWER CONNECTIONS	2-1
2.4 RACK MOUNTING	2-1
2.5 LINE-VOLTAGE REGULATION	2-3

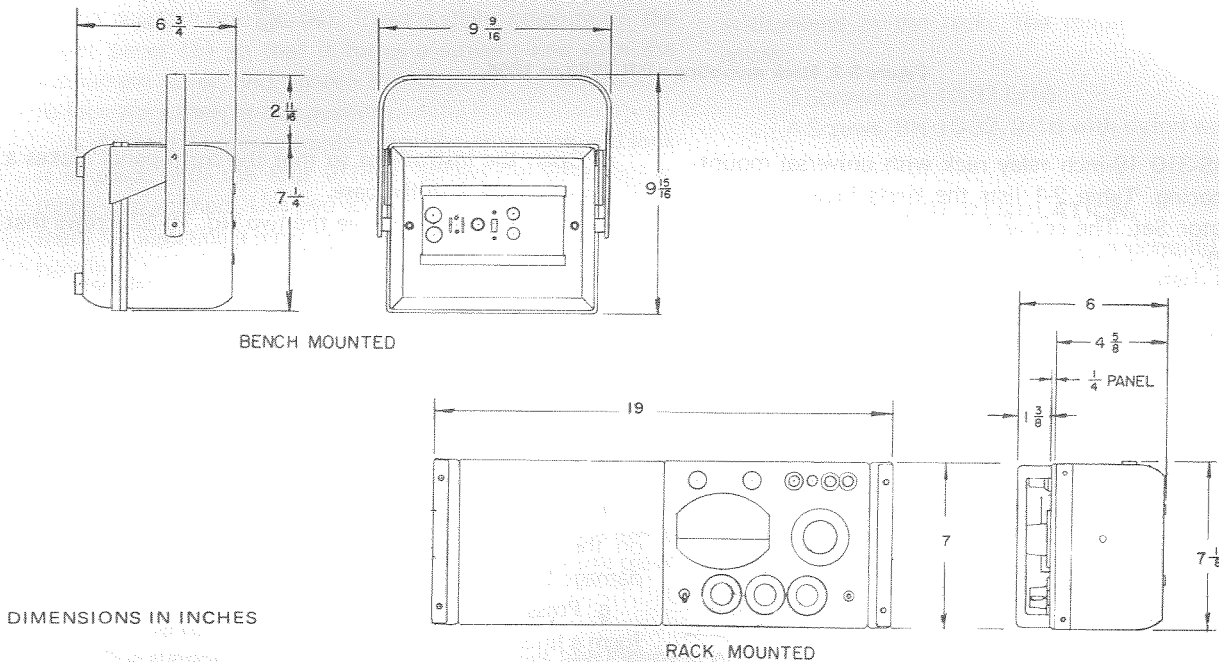

Figure 2-1. Dimensions of the GR 1863 and 1864 Megohmmeters.

2.1 DIMENSIONS.

The dimensions of the 1863 and 1864 are shown in both the rack- and bench-mounted configurations in Figure 2-1.

2.2 BENCH MOUNTING.

The bench (portable) model of the megohmmeter is cased in a Flip-Tilt cabinet. The cabinet opens by pushing down on the handle and tipping the instrument into the desired operating position (paragraph 1.2).

2.3 POWER CONNECTIONS.

The 1863 and 1864 Megohmmeters can be operated from either a 100- to 125-V or a 200- to 250-V, 50-to 60-Hz power line. Before connecting the 3-wire power cord to the line, set the slide switch on the rear panel to the

proper setting as indicated by the position of the white line on the slide switch. The slide can be moved with a screwdriver blade. The fuses installed in the instrument are connected so that they will protect the unit for either voltage. If it is necessary to use a 3-wire adaptor plug, make certain that the third wire is connected to a good ground (water pipe or equivalent). If this is not possible, connect the panel of the 1863 or 1864 (uninsulated binding post) to a good ground.

2.4 RACK MOUNTING.

2.4.1 Single Instrument and Blank Panel (Figure 2-2).

A Rack Adaptor Set (P/N 0480-9744) is available to convert the portable bench model for use in an EIA opposite directions, one from inside the cabinet and one

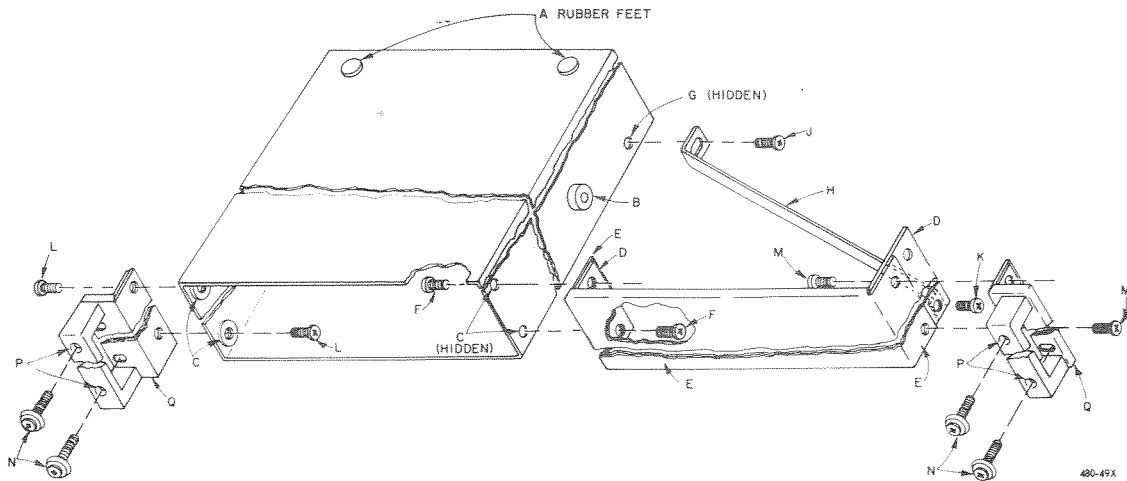

Figure 2-2. Rack mounting a GR 1863 or 1864.

standard RS-310 19-inch relay rack with universal mounting hole spacing. Table 2-1 lists the parts included in the Rack Adaptor Set. The conversion procedure is as follows (Figure 2-2):

Table 2-1

PARTS INCLUDED IN THE RACK ADAPTOR SET,
P/N 0480-9744 (see Figure 2-2).

Figure 2-2 Reference	Number Used	Item	GR Part Number
E	1	Blank Panel	0480-8934
D	1	Sub-Panel	0480-8954
—	2	Rack Adaptor Assembly (handle)	0480-4904
H	1	Support Bracket	0480-8523
—	1	Hardware Set includes:	0480-3080
F, J, K, L, M		8 Screws, Binder-Head 10-32, 5/16 in.	—
N		4 Screws, Binder-Head 10-32, 9/16 in. with nylon cup washer	—

a. Open the instrument so that the front-panel makes a 90-degree angle with the base.

b. From the rear, remove the two No. 10-32 screws that hold the instrument in the cabinet.

c. Slide the instrument forward out of the cabinet.

d. Remove the two O-rings, one on each side of the cabinet (Figure 7-10, P/N 5210-0200). (Use Waldes TRUARC* Assembly Pliers No. 0100 or equivalent.)

e. Remove the two pins (Figure 7-10, pivot shaft), one from each side of the cabinet, and slide the cabinet from between the handle ends.

f. Pierce and push out the plugs from the four bosses (C) on the inner sides of the cabinet, near the front. Do not damage the threads in the threaded holes.

g. Press the subpanel (D) into the blank panel (E), to form a liner for the latter.

h. Attach the short flange of the blank panel to the front of the cabinet (on either side of the cabinet, as desired) using two 5/16-in. screws (F). Note that the screws enter in opposite directions — one from inside the cabinet and one from the flange side, as shown and that the feet (A) are on top.

i. Pierce and push out the plug in the lower rear boss (G) on the side toward the blank panel only, as shown.

j. Attach one end of the support bracket (H) to the lower rear boss. The bracket must be placed so that the screw passes through a clearance hole, into a tapped hole. Lock the bracket in position with a 5/16-in. screw (J).

k. Attach the other end of the support bracket to the lower, rear hole in the wide flange, as shown, using a 5/16-in. screw (K).

l. Attach one Rack Adaptor Assembly (handle) to the side of the cabinet opposite the blank panel, using two 5/16-in. screws (L). Again, note that the screws enter in

*Registered trademark of Truarc Retaining Rings Division, Waldes Kohinoor, Inc., Long Island City, N.Y. 11101.

from outside. Use the upper and lower holes in the Assembly.

m. Attach the other Rack Adaptor Assembly (handle) to the wide flange on liner (D) and the flange on the blank panel (E). Use two 5/16-in. screws (M) through the two holes in the flange that are nearest the panel and through the upper and lower holes in the Assembly. Again, the screws enter in opposite directions.

n. Carefully remove the rubber gasket that is around the instrument panel. Note: Use fingers, not tools.

o. Install the instrument in the cabinet and replace the two No. 10-32 screws removed in step b through the rear panel and tighten.

p. Place a straight edge across both the instrument panel and the blank panel. Loosen the screw (J) through the slot in the support bracket (H). Exert a slight pressure on the blank panel (E) so that it forms a straight line with the instrument panel, and tighten the screw (J) in the bracket, to lock the panels in this position.

q. Slide the entire assembly into the relay rack and lock it in place with the four 9/16-in. screws (N) with captive nylon cup washers. Use two screws on each side and tighten them by inserting a screwdriver through the holes (P) in the handles.

r. Insert the instrument at a slight angle, left end first, to avoid hitting the cabinet spacer on the rack rail. If your rack won't allow this procedure, refer to paragraph 2.4.3 and read the CAUTION.

2.4.2 Reverting to Portable Bench Mounting.

To revert the instrument for bench use, (assuming the procedure of paragraph 2.4.3 has not been performed) reverse the procedures of paragraph 2.4.1, first removing the entire assembly of instrument, cabinet, and blank panel from the rack. Next remove:

a. The instrument from its cabinet.

b. The support bracket (H) from the cabinet (see Figure 2-2).

c. The blank panel (E) (with handle attached) from one side of the cabinet.

d. The Rack Adaptor Set (handle) from the other side of the cabinet.

Install the instrument in its cabinet and tighten the two No. 10-32 screws at the rear.

2.4.3 Rack-mounting Two Instruments.

Two instruments of the same panel size (such as two 1863's or 1864's or one of each) can be mounted

side-by-side in a standard 19-inch relay rack. Use the procedure of paragraph 2.4.1, substituting the second instrument for the blank panel. Do not use the support bracket (H, Figure 2-2), but insert three screws through the bosses in the adjacent sides of the cabinets, two near the front (C) and one near the rear (G).

When two instruments are mounted side-by-side, the two spacers (B, one on each side of the cabinet) must be punched out of the cabinet.

CAUTION

Once this is done the instruments cannot be reinstalled in a Flip-Tilt cabinet.

Use the four screws (N) with nylon washers to lock the instruments in the rack. The required hardware is listed below:

3 Screws, BH 10-32 5/16

4 Screws, BH 10-32, 9/16 with nylon washers

2.5 LINE-VOLTAGE REGULATION.

The accuracy of measurements accomplished with precision electronic test equipment operated from ac line sources can often be seriously degraded by fluctuations in primary input power. Line-voltage variations as much as $\pm 5\%$ are commonly encountered, even in laboratory environments. Although most modern electronic instruments incorporate some degree of line-voltage regulation, consideration to possible power-source problems should be given for every instrumentation set-up. The use of line-voltage regulators between power lines and the test equipment is recommended as the only sure way to eliminate the effects on measurement data by low line voltage, transients, and other power phenomena.

The General Radio Type 1591 Variac® Automatic Voltage Regulator is a compact and inexpensive unit capable of holding ac power within $\pm 0.2\%$ accuracy for up to a rack full of solid-state instrumentation. The 1591 possesses a basic capacity of 1 kVA with no distortion of input waveform. This rugged electromechanical regulator comes in bench or rack-mount configurations, both of which permit direct plug-in of measurement-instrument power cords.

Further details can be found in your GR catalog or in the GR *Experimenter* for October, 1967.

Operation – Section 3

3.1 MEASUREMENT SETUP	3-1
3.2 MEASUREMENT PROCEDURE	3-1
3.3 OUTPUT JACK	3-2

3.1 MEASUREMENT SETUP.

3.1.1 Ground-Link Connection.

The grounding link connected to the uninsulated, grounded, binding post can be connected from this ground terminal to the GUARD (paragraph 4.6) or the + UNKNOWN terminal (Figure 3-1). The ground link should be connected to the GUARD terminal if the sample to be measured is a small, separate component, or if it is a component mounted in an enclosure that should be guarded (paragraph 4.6). However, if one terminal of the unknown must be grounded, then the link should tie the + UNKNOWN terminal to the instrument case.

3.1.2 Test Voltage Selection.

The TEST VOLTAGE switch(es) should be set to the desired measurement voltage. The 1863 Megohmmeter has five individual test voltages, 50, 100, 200, 250, and 500 V. The 1864 Megohmmeter has a selection of 10 to 109 V in 1-V steps or 100 to 1090 V in 10-V steps. On the 1864 the right-hand TEST VOLTAGE switch must be set to the V position for the first set of voltages and to the 0V position for the latter set of voltages.

3.1.3 Set ∞ Adjustments.

To adjust the SET ∞ controls, proceed as follows:

- Turn the instrument on.
- Set the function switch to DISCHARGE.
- Set the multiplier dial to any range.

d. Make certain that there isn't anything connected to the UNKNOWN terminals.

e. Adjust the SET ∞ control for an ∞ reading on the meter. The adjustment on the 1863 is made with a screwdriver; on the 1864 with the knob provided.

f. Set the multiplier switch to the highest range (Type 1863, 1T-100G; Type 1864, 10-1T).

g. Set the function switch to MEASURE.

h. Adjust the SET ∞ HIGHEST RANGE on the 1863 (screwdriver adjustment) or 1864 (knob adjustment) for an ∞ meter reading. If these adjustments cannot be set to give an on-scale reading, turn the instrument off and adjust the mechanical meter adjustment (the center screw on the meter) to give a meter reading of less than a line width beyond ∞ . Repeat steps a through g.

3.1.4 Connection of Unknown.

Small components should be connected directly to the UNKNOWN terminals. Insulated leads (GR 274-LSR Single-Plug Patch Cord, Table 1-4) can be connected to a nearby unknown, however, if the unknown resistance is high, leakage between the leads will cause a measurement error and changing capacitance to the high lead will cause a transient meter deflection. For such high resistance measurements, a shielded system is preferable (refer to paragraph 4.7).

3.2 MEASUREMENT PROCEDURE.

3.2.1 General.

Either of two measurement procedures is used, depending on whether or not the correct resistance-multiplier range is known. If the range is not known, the search procedure (paragraph 3.2.2) should be followed. If repetitive measurements are to be made on a given range (i.e., if similar components are to be sorted) the sort procedure (paragraph 3.2.3) should be used.

3.2.2 Search Procedure.

When the approximate resistance of the sample to be measured is not known, proceed as follows:

- Set the multiplier switch to the lowest range.
- Set the function switch to DISCHARGE.

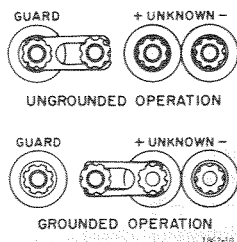

Figure 3-1. Ground-link connection to GUARD terminal (top) and to + UNKNOWN terminal (bottom).

- c. Connect the unknown between the UNKNOWN + and – terminals.
- d. Set the function switch to MEASURE.
- e. Rotate the multiplier switch cw until the meter gives a reading of less than 5.
- f. The resistance of the unknown is the meter reading multiplied by the multiplier-switch indication.

3.2.3 Sort Procedure.

When the approximate resistance of the unknown is known, proceed as follows:

- a. Set the function switch to DISCHARGE.
- b. Set the multiplier switch to the desired range.
- c. Connect the unknown between the UNKNOWN + and – terminals.
- d. Set the function switch to MEASURE.
- e. The resistance of the unknown is the meter reading multiplied by the multiplier-switch indication. For go-no-go checks, it is often useful to draw a limit line on the outside of the meter case with a wax pencil.

3.2.4 Shock Hazard.

Every precaution has been taken in the design of the Types 1863 and 1864 Megohmmeters to reduce the possibility of shock. However, high voltage must be present at the terminals to make measurements at the required voltage levels and the operator should be aware of the dangers involved.

The current delivered by the megohmmeters under short-circuit conditions is approximately 5 mA. This 5-mA current is not lethal to most persons but might be lethal to those with poor hearts, and it is painful to all. The actual current that will flow through a person depends on the resistance of the part of the body that makes contact with the terminals. This resistance can be as low as 300 Ω. Note that any of the three insulated binding posts can be at high voltage, depending on the position of the shorting link.

When capacitors are tested there is an especially dangerous condition because a charged capacitor easily can have enough energy to cause heart fibrillation and death. The capacitor should *always* be shunted before connection to the megohmmeter, and the function switch should be set to DISCHARGE for a few seconds before the capacitor is disconnected.

We strongly recommend that additional precautions, such as rubber gloves and insulated bench tops, chairs and shoes should be used for anyone making repetitive measurements with the megohmmeter, particularly measurements on capacitors. These precautions should *not* take the place of careful discharge of the capacitors before and after measurement, but should be used as an *additional* safety measure.

3.3 OUTPUT JACK.

The OUTPUT jack (J105) on the rear panel makes accessible a dc voltage that is directly proportional to the reciprocal of the meter reading, that is, the highest value is at 0.5 scale reading and the lowest value is at ∞. The output voltage for a particular multiplier-switch setting can be calculated by

$$V_{out} = 0.02 V_{TEST} \times \frac{R_{RANGE}}{R_x}$$

where V_{TEST} is the TEST VOLTAGE setting, R_{RANGE} is the lower value for a particular multiplier-dial setting (100k for the 1M/100 k range) and R_x is the value of the resistance being measured.

The output can be plotted on a dc level recorder, such as the GR 1521 Graphic Level Recorder (P/N 1521-9802) with a 1521-P4 Linear Potentiometer (P/N 1521-9604) and a general use, 1/4 in. division chart paper (P/N 1521-9428). A GR 1560-P95 Adaptor Cable can be used to connect the OUTPUT jack to the recorder. The full-scale voltage value for any test voltage can be calculated from the V_{out} formula using 0.5 times the measurement range as the R_x value. Table 3-1 lists the full-scale voltage values for the five test voltages of the 1863. These values are also available on the 1864 along with the other levels that can be set with the variable TEST VOLTAGE switches.

The GR 1782 Analog Limit Comparator can be used to establish limits for go-no-go checks of a series of components being measured by 1863 or 1864. The 1782 has a full-scale voltage of 10 V, whereas the maximum voltage from the megohmmeters is 4 V. The fact that a full-scale value cannot be reached does not affect the usefulness of the comparator with the megohmmeters.

Table 3-1
OUTPUT VOLTAGE*

Test Voltage (V)	Lower Multiplier-Dial Setting		Upper-Multiplier-Dial Setting		
	50	100	200	250	500
Full-Scale Output Voltage (V)	2	4	0.8	1	2

* V_{OUT} at 0.5 scale reading.

Applications—Section 4

4.1 INSULATION TESTING	4-1
4.2 TEST SAMPLE RESISTIVITY MEASUREMENTS	4-2
4.3 CAPACITOR INSULATION RESISTANCE	4-2
4.4 RESISTANCE MEASUREMENTS	4-3
4.5 MEASUREMENT OF VOLTAGE COEFFICIENTS	4-3
4.6 GUARDED, 3-TERMINAL MEASUREMENTS	4-3
4.7 REMOTE SHIELDED MEASUREMENTS	4-4
4.8 MEASUREMENTS UNDER HUMID CONDITONS	4-4

4.1 INSULATION TESTING.

The insulation resistance of electrical machinery, transducers, etc, is one of several parameters that may indicate the condition of the insulation. Routine measurement of capacitance, dissipation factor, and leakage resistance provides useful data for monitoring the condition of the insulation and for guarding against incipient breakdown.

A routine test that has been widely adopted for insulation testing calls for the measurement of the apparent leakage resistance after a test voltage has been applied for one minute and again after the test voltage has been applied for 10 minutes. The ratio of the indicated resistances, sometimes referred to as the Polarization Index, can have some relation to the condition of the Insulation. The results of such a measurement are apt to be more dependent on the dielectric absorption of the insulator than on its true leakage resistance measured at equilibrium. A complete charge-current-vs-time plot will provide more useful information.

The Type 1863 and 1864 Megohmmeters can be used for either true leakage measurements or for measurements at 1- or 10-minute intervals following the operating procedure described in Section 3. MIL-STD-202C gives procedures for insulation-resistance measurements of various components. On large machinery, one terminal must usually be grounded, so the grounding strap should be connected between the ground terminal and the + UNKNOWN terminal.

To determine the charge current, divide the test voltage by the indicated resistance. At the start of a

Table 4-1
STANDARD RESISTOR VALUES (R_3)

Multiplier Range		Value (Ω)
Lower Dial	Upper Dial	
50, 100 V* 10 to 109 V [†]	200, 250, 500 V* 100 to 1000 V [†]	
100 k	1M	2 k
1 M	10 M	20 k
10 M	100 M	200 k
100 M	1 G	2 M
1 G	10 G	20 M
10 G	100 G	200 M
100 G	1 T	200 M with feedback multiplication* 2 G [†]
1 T	10 T	2 G with feedback multiplication [†]

*Type 1863 Megohmmeter
†Type 1864 Megohmmeter

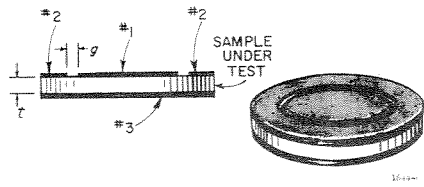

Figure 4-1. Electrode arrangement for resistivity measurements.

charge-current-vs-time plot, the meter will be off scale. The resistance in series with the insulator is the reading of the upper dial multiplier divided by 500. Table 4-1 lists dial readings and resistor values.

4.2 TEST SAMPLE RESISTIVITY MEASUREMENTS.

The megohmmeter can be used for measuring the resistivity of test samples as described by ASTM Standard D257, which describes in detail the techniques for both surface-and volume-resistivity measurements. The most common electrode arrangement is that shown in Figure 4-1. In this configuration surface resistivity is measured with terminal 1 tied to the -UNKNOWN terminal, terminal 2 tied to the +UNKNOWN terminal and terminal 3 tied to GUARD. For volume resistivity measurements, terminal 1 is tied to the -UNKNOWN terminal, terminal 2 to the GUARD and terminal 3 to the +UNKNOWN terminal. The formulas required to convert from measured resistance to resistivity are given in the ASTM standard. The Keithley Model 6105 Test Fixture can be used to hold the sample to be measured.

4.3 CAPACITOR INSULATION RESISTANCE.

4.3.1 General.

The insulation resistance, IR, of capacitors (MIL-STD-202 C) is measured by either the search or sort method (paragraph 3.2.2 and 3.2.3) used for resistors, except that some consideration must be given to the charge and discharge currents.

WARNING

Capacitors being measured may be charged and contain lethal energy. Always set the function switch to DISCHARGE before connecting or disconnecting the capacitor under test.

4.3.2 Charging Time Constant.

The time constant for charging a capacitor in the CHARGE position is determined by the value of the capacitor times the effective source impedance of the supply. The supply resistance is approximately,

$$R_o = \frac{E}{I_{max}} \Omega = \frac{E}{0.005 A} \Omega = \frac{E}{5} k\Omega$$

where E is the indicated test voltage in volts and I_{max} is the short-circuit current, which is approximately 5 mA. Therefore, the time constant is

$$T = R_o C_x = \frac{E C_x}{5000} \text{ seconds}$$

where C_x is in μF . As an example, on the 500-V range, R_o is approximately 100 k Ω so that the time constant for charging of a 1- μF capacitor is 0.1 s.

The time necessary for full charging depends on the type of capacitor and the leakage current that is to be measured. A capacitor with no dielectric absorption will have a charging current that decreases by a factor of 2.72 (the natural logarithm to the base e) for every time constant it is left in the CHARGE position. Thus, the effective resistance

at any moment is $R_o e^{-\frac{t}{R_o C_x}}$. The capacitor could be considered fully charged when this resistance is substantially higher than the true leakage resistance, even though the charging current theoretically never reaches zero. As an example a 1- μF capacitor, with a leakage resistance of $10^{10} \Omega$ measured at 500 V, would have less than 1% error due to charging current, if measured after seventeen time constants, or 1.7 s.

Dielectric absorption (dipole and interfacial polarization) is present in many capacitors and insulators, especially those with a laminated structure. When voltage is applied to such material, the charge slowly diffuses throughout the volume and several minutes, hours, or even days, are required for equilibrium in order to make the charging current small compared with the true leakage current. A measure of this effect, called the Polarization Index, is the ratio of the resistance measured after 10 minutes of charging to that measured after 1 minute of charging. Often, the measured resistance after 1 minute of charging is called the insulation resistance, even though charging current may be much larger than the true leakage current. (Some capacitor specifications say less than 2 minutes).

4.3.3 Measurement Time Constant.

When the function switch is set from the CHARGE position to the MEASURE position, the standard resistor is placed in series with the unknown capacitor. If the supply voltage is fixed, the capacitor must discharge by a voltage equal to that across the voltmeter at its final reading. The time constant for this discharge would be $C_x R_s$. Because 80% of the output voltage is fed back to the supply, this time constant is reduced by a factor of 5. As a result, the time necessary for an indication, assuming an ideal capacitor, depends on this time constant or that of the meter movement, whichever is longer.

4.3.4 Discharge Time.

With the function switch set at DISCHARGE, the UNKNOWN terminals are connected through 470 Ω and the discharge time is approximately $0.0005 \times C \mu s$, where C is in μF . The red DANGER light is turned off by the

function switch, so that the capacitor might be charged even after the light is extinguished. However, the discharge time is so short that this is not a practical consideration, except for capacitors greater than 100 μF .

Capacitors with high dielectric absorption (paragraph 4.3.2) can have a residual charge even after they are shunted and must be repeatedly shunted to be completely discharged. Usually this "voltage recovery" is only a few percent (i.e., 3%) of the original applied voltage and, therefore, not dangerous to the operator, but it can cause damage to sensitive circuit elements.

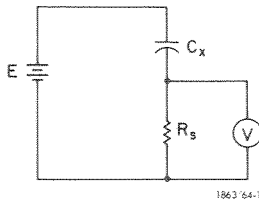

Figure 4-2. Basic megohmmeter circuit.

4.3.5 Large Capacitors, Very High Resistance

Measuring insulation resistance of large capacitors that have very low leakage is difficult by any method. Considering the basic circuit of Figure 4-2, if R_s is high, the $R_s C_x$ time constant can become very long on the high resistance ranges if C_x is large. If R_s is low, the voltmeter must be very sensitive for a given leakage resistance range and, therefore, the supply voltage (E) must be extremely stable to avoid large meter fluctuations. The design of the 1863 and 1864 is a compromise between these factors. Measurements become difficult when the $R_s C_x$ product is 10^6 , even under ideal conditions. This can be calculated as (C_x in μF) \times (R_s in $\text{M}\Omega$) or (C_x in F) \times (R_s in Ω). Table 4-1 contains values for R_s .

Measurements can be unsatisfactory even below this value for an $R_s C_x$ product for several reasons:

- 1 Dielectric absorption. (paragraph 4.3.2). This is the main cause of erroneous readings. Besides the difficulty in deciding what charging period should be used, the previous history of the capacitor will greatly affect its indicated leakage. For example, if a paper capacitor is charged to its rated value, discharged for a short time, and then its leakage current is measured at some low value, it probably will give a reading beyond ∞ . This is due to voltage recovery that is a consequence of dielectric absorption. The voltage across the capacitor will increase above the test voltage causing current to flow in the reverse direction.

2. Temperature coefficient. If the temperature on the unknown changes and it has an appreciable temperature coefficient, the voltage on the capacitor will change in the MEASURE position. If R_s is large, the charge, Q , of the capacitor is more-or-less constant, so if its capacitance

changes, its voltage must change ($Q=CV$). A temperature-controlled environment is recommended.

3. Test voltage changes. The test voltage can have rapid fluctuations due to large line-voltage transients even though good regulation is provided in the instrument because when $R_s C_x$ is large, the test voltage fluctuations are transmitted directly to the voltmeter unattenuated. This difficulty can be reduced if the line voltage is regulated with an instrument such as GR 1591 Variac® Automatic Voltage Regulator.

Slow drift of the test voltage can cause erroneous readings if $R_s C_x$ is large, because even a slow drift rate can be fast compared to the $R_s C_x$ time constant. A decreasing test voltage can cause a reading beyond ∞ . Sufficient warm-up time (30 minutes) will allow the temperature inside the megohmmeter to stabilize and result in a more constant voltage at the UNKNOWN terminals.

4.4 RESISTANCE MEASUREMENTS.

The recommended test voltage is 100 V for fixed composition resistors, film resistors, and wire-wound resistors above 100 $\text{k}\Omega$. (Refer to EIA Standards RS172, RS196, and REC 229.) These resistors can be measured easily on the megohmmeter as long as the accuracy of the instrument is adequate. If the resistors are separate, we suggest that they be measured ungrounded (with the grounding link connected to the GUARD terminal).

4.5 MEASUREMENT OF VOLTAGE COEFFICIENT.

The Types 1863 and 1864 Megohmmeters may be used to measure voltage coefficient as long as its accuracy is adequate. The voltage coefficient of resistance is defined as:

$$\frac{R_1 - R_2}{R_2 (V_1 - V_2)} \times 100 \%$$

where $V_1 > V_2$

R_1 is the resistance at V_1 , the higher voltage

R_2 is the resistance at V_2

For example, if $V_1 = 500 \text{ V}$ and $V_2 = 100 \text{ V}$,

$$\begin{aligned} \text{Voltage Coefficient} &= \frac{R_{500 \text{ V}} - R_{100 \text{ V}}}{(400) R_{100 \text{ V}}} \times 100\% \\ &= \frac{1}{4} \frac{\Delta R}{R_{100 \text{ V}}} \% \end{aligned}$$

This voltage coefficient is usually negative (except for reversed semiconductor junctions).

4.6 GUARDED, 3-TERMINAL MEASUREMENTS.

In many cases it is necessary to measure the resistance between two points in the presence of resistance from each of these points to a third point. This third point can often be guarded to avoid error caused by the extraneous resistances.

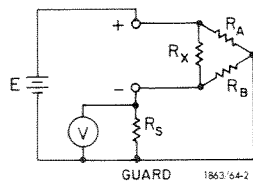

Figure 4-3. Guarded measurement of a three-terminal resistor.

This situation can be shown diagrammatically as a three-terminal resistor (Figure 4-3). Here, R_X is the quantity to be measured in the presence of R_A and R_B . If the junction of R_A and R_B is tied to a guard, R_A is placed across the power supply and has no effect if it is greater than 500 k Ω . R_B shunts R_S and causes a much smaller error than that which would be present if no guard were used. The error is approximately $-R_S/R_B \times 100\%$, where R_S equals 2000 k Ω times the multiplier switch indication. If a choice is possible, the higher of the two stray resistances should be connected as R_B .

The guard terminal can be used whether the GUARD or the + UNKNOWN terminal is grounded, but note that if the + UNKNOWN terminal is grounded, the GUARD terminal will be a high (negative) voltage level. Often the terminal to be guarded is a large chassis and it is, therefore, safer to ground the GUARD terminal. If this third terminal is true ground then the GUARD terminal *must* be grounded.

4.7 REMOTE SHIELDED MEASUREMENTS .

Measurements can be made on components that are some distance from the instrument if care is used to prevent

leakage between the connecting leads and to avoid the shock hazard. A convenient way to do this is to use a shielded cable (Table 1-4). If the unknown can be measured ungrounded, make the connection to the + UNKNOWN terminal with the shielded lead, tie the shield to the GUARD terminal, and connect the GUARD terminal to the panel ground with the connecting link. If one side of the unknown must be grounded, connect the grounding link to the + UNKNOWN terminal, shield the + UNKNOWN terminal, and tie the shield to the GUARD terminal. In this instance, the shield is not at ground potential and should be insulated.

4.8 MEASUREMENTS UNDER HUMID CONDITIONS.

The Types 1863 and 1864 Megohmmeters have been designed to operate under conditions of high humidity but, nevertheless, a few simple precautions should be taken to ensure accurate measurements. These precautions are:

1. Allow several minutes warmup (internal heat will reduce humidity inside the instrument).
2. Clean the binding-post insulation with a dry, clean cloth.
3. Use ungrounded operation (tie the GUARD terminal to the panel ground).

To determine the presence of errors due to humidity, measure the resistance between the binding posts with no external connections. Note that with the + UNKNOWN terminal grounded, breathing on the terminals will cause a meter deflection because leakage from the insulator of the - UNKNOWN terminal to the panel is measured.

Actually, this problem is somewhat academic because the unknown to be measured is usually much more severely affected by humidity than is the megohmmeter.

Theory—Section 5

5.1 GENERAL	5-1
5.2 CIRCUIT DESCRIPTION	5-1

5.1 GENERAL.

The 1863 and 1864 Megohmmeters basically consist of a regulated dc power supply, a set of precision resistors, and a FET-input voltmeter (Figure 5-1). Switch S_1 is closed in the DISCHARGE position of the function switch and open in the CHARGE and MEASURE positions, while S_2 is open only in the MEASURE position.

The regulated voltage, E , is controlled by a resistance R_A . A fraction, E_M of the meter output voltage, $E_X R_S / R_X$ is added to E to keep the voltage on the unknown, E_X , more constant and thus improve the meter accuracy. A meter sensitivity resistor, R_B , is ganged to the voltage control resistor, R_A , to make the meter reading independent of applied voltage, (assuming that the unknown has no voltage coefficient). An inverse scale is used on a reversed meter to give a reading proportional to R_X (and not its reciprocal) and yet have a scale that increases from left to right (0 to ∞).

Metal-film standard resistors are used on the five lowest ranges (lowest range $\pm 1/2\%$ next four ranges $\pm 1\%$). The sixth range in the 1863 uses a 200-M Ω carbon resistor ($\pm 1\%$). The sixth range in the 1864 uses a 200-M Ω carbon resistor ($\pm 1\%$) and the seventh range a 2-G Ω carbon resistor ($\pm 1\%$). The use of carbon resistors makes it necessary to broaden the accuracy specification to include possible drift in this standard. The top range of each instrument uses feedback to effectively multiply the value of the previous standard resistor by a factor of ten. In the 1863 the 200-M Ω resistor is multiplied to 2 G Ω ; in the 1864 the 2-G Ω resistor is multiplied to 20 G Ω . The specifications are again broadened to allow for the tolerance variations of this multiplication.

The voltmeter uses a FET-input, four-stage, unity-gain amplifier (AMP, Figure 5-1) to obtain high stability and low drift. The SET ∞ control on both instruments is a voltage balance control, while the SET ∞ HIGHEST RANGE control compensates for the FET gate current on the highest ranges.

5.2 CIRCUIT DESCRIPTION.

5.2.1 General.

The following paragraphs will relate specific components from the schematic diagrams of the 1863 (Figure 7-6) and 1864 (Figure 7-9) to the general components shown in Figure 5-1.

5.2.2 Type 1863 Megohmmeter (Figure 7-6).

The voltage supply section (RECT.) of the 1863 consists of five different circuits, three dc and two ac. One ac circuit is a voltage source for the three pilot lamps used, two to indicate the measurement range (P101, P102) and the third to light the DANGER indicator (P103). The second supplies filament voltage to the tube V101.

The first dc supply is a half-wave rectifier circuit with a 24-V Zener diode (CR111) that supplies voltages to the amplifier (AMP) circuit. A second dc supply is a voltage doubler (CR101-CR104, C101-C102) that supplies the plate voltage to V101. The voltage to the plate is the same for the 50- to 250-V ranges but R109 is eliminated from the circuit for the 500-V range. The third dc supply is a half-wave rectifier with a 20-V Zener diode (CR211) to supply voltage levels to run the unity-gain amplifier (+1).

Tube V101 is a series regulator that is controlled by the 5.6-V Zener diode (CR112, REF) and the setting of R140.

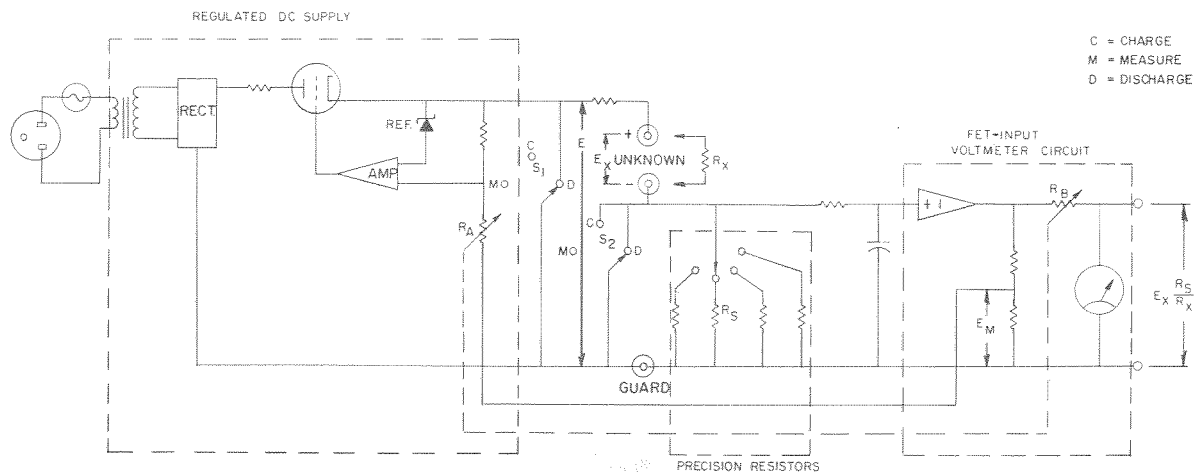

Figure 5-1. Megohmmeter block diagram.

The voltage picked off R140 is fed into one side (Q102) of the differential amplifier (Q102, Q103) while part of the output voltage is fed into the other side (Q103). The output of the amplifier is fed to the base of Q101 (AMP) and then to the grid of V101 for controlling the output voltage.

The output selection resistors are R124 through R127 (R_A). These resistors along with the voltage (E_M) developed across R138 determine the TEST VOLTAGE level. Resistors R211 through R219 are the standard resistors (R_S) that determine the measurement range. The output from this circuit is fed through the SET ∞ HIGHEST RANGE control (R241) to the FET amplifier.

A unity-gain FET-input amplifier (+1) follows the standard resistors in the circuit configuration. R210 and C203 comprise a low-pass filter input to FET Q204. The amplifier components include a differential amplifier (Q202, Q203), a coarse ∞ control (R244), the SET ∞ control (R242) and an output transistor (Q201). The signal then enters the series combination of R135 and R134 back to the GUARD terminal.

Resistors R221 through R223 (R_B) are meter-sensitivity resistors that are ganged to the voltage resistors R124

through R127 (R_A). R222 is used for both the 50- and 500-V ranges, while the 200-V range uses the circuit resistance and has no added resistor. The remaining two resistors, R221 and R223, are used for the 250- and 100-V ranges, respectively. Potentiometer R243 is an adjustable control on the meter sensitivity.

5.2.3 Type 1864 Megohmmeter (Figure 7-9).

The circuit of the 1864 Megohmmeter is basically the same as that of the 1863 (paragraph 5.2.2). The exceptions are explained in the following paragraphs.

In the 1864 the second dc power supply is a quadrupler. This supply establishes the plate voltage of V101 with the use of resistors R109 through R114.

The regulator circuit has a slightly different input when the TEST VOLTAGE switch is switched from V (1) to 0V (10). Resistors R124 and R125 are switched out of the circuit in the 0V (10) position.

Voltage-selection resistors for the 1864 are R126 through R133 and the meter sensitivity resistors are R221 through R228. An additional range resistor, R220, is in the 1864.

Service and Maintenance—Section 6

6.1 SERVICE	6-1
6.2 MINIMUM-PERFORMANCE STANDARDS	6-1
6.3 CABINET REMOVAL	6-2
6.4 TROUBLE ANALYSIS	6-3
6.5 CALIBRATION PROCEDURE	6-3
6.6 KNOB REMOVAL	6-4
6.7 KNOB INSTALLATION	6-5

6.1 SERVICE.

The warranty attests the quality of materials and workmanship in our products. When difficulties do occur, our service engineers will assist in any way possible. If the difficulty cannot be eliminated by use of the following service instructions, please write or phone our Service Department (see last page of manual), giving full information of the trouble and of steps taken to remedy it. Be sure to mention the type, ID, and serial numbers of the instrument.

Before returning an instrument to General Radio for service, please write to our Service Department or nearest District Office, requesting a "Returned Material Tag." Use of this tag will ensure proper handling and identification. For instruments not covered by the warranty, a purchase order should be forwarded to avoid unnecessary delay.

6.2 MINIMUM-PERFORMANCE STANDARDS.

The following checks are provided for checking the operation of the 1863 and 1864 Megohmmeters. The test equipment necessary to perform these checks is listed in Table 5-1. To check an instrument, proceed as follows:

a. Connect the case to the GUARD terminal with the shorting link.

b. Connect a GR 1433-H Decade Resistor to the UNKNOWN terminals with a GR 274-NPS Double-Plug Patch Cord (12 in.).

c. Set the decade resistor to 0500000 (500 k Ω).

d. Set the TEST VOLTAGE switch to 100 on the 1863 or to 1-0-0V on the 1864.

e. Set the multiplier switch to 1M.

f. Set the POWER-OFF switch to POWER.

g. Adjust the two SET ∞ controls as described in Section 3.

h. Set the function switch to MEASURE.

i. Read the panel meter. The reading will be $0.5 \pm 3\%$, that is, $\pm 2 (1 + \text{meter reading})\%$ or $2 (1 + 0.5) = 3\%$.

j. Set the decade resistor to 01000000 (1M Ω).

k. The meter will read $1 \pm 4\%$.

l. Set the decade resistor to 05000000 (5 M Ω).

m. The meter will read $5 \pm 12\%$. The checks of steps a through m are for meter tracking.

n. Set the TEST VOLTAGE switch to 50 on the 1863 and to 10 V on the 1864.

o. Set decades to 0500000 (500 k Ω), MULTIPLIER to 1M.

p. The meter will read $0.5 \pm 3\%$.

q. Increase the voltage to the next higher step (100 on the 1863, 20 V on the 1864).

r. The meter reading will remain the same.

s. Continue to increase the voltage settings and observe that the meter reading remains at $0.5 \pm 3\%$. These readings will check the voltage accuracy.

NOTE

When the light under the 1M on the multiplier switch goes out, the switch must be rotated so that the 1M on the adjacent scale is lighted.

t. Set the POWER-OFF switch to OFF and disconnect the decade resistor.

Table 6-1
TEST EQUIPMENT

Name	Function	Recommended Equipment*
DECADE RESISTOR	Standard resistor ($\pm 0.02\%$) for checking ranges (500 k Ω to 10 M Ω).	GR 1433-H Decade Resistor (P/N 1433-9734)
MEGOHM BRIDGE	Bridge for measuring the standard resistors of the megohmmeter.	GR 1644 Megohm Bridge
PATCH CORD	Connects decade resistor to megohmmeter.	GR 274-NPS Double-Plug Patch Cord, Right-Angle Plug, 12-in. long (P/N 0274-9852)
PATCH CORD	Connect megohm bridge to megohmmeter (3 required).	GR 274-LSB Single-Plug Patch Cord, black, 12-in. long (P/N 0274-9849)
EVM	Measurement of dc and ac voltages.	GR 1806 Electronic Voltmeter (P/N 1806-9701)
SCREWDRIVER	No. 2 Phillips-head screwdriver for internal adjustments.	Xcelite Type X-102 Phillips Screwdriver

*or equivalent

u. Connect the GR 1644 Megohm Bridge between the GUARD and -UNKNOWN terminals with two GR 274-LSB Single-Plug Patch Cords. Connect the two ground terminals together with a third patch cord (Figure 6-1). Leave the megohmmeter shorting link attached only to the ground terminal.

v. Set the multiplier switch in the full ccw position (1M, 100k) and the function switch to MEASURE.

w. Measure the various standard resistors of the megohmmeter with the megohm bridge according to the settings and tolerances of Table 6-2. Take into consideration the 1644 bridge-accuracy tolerance for the final measurement. Use a test voltage of 10 V.

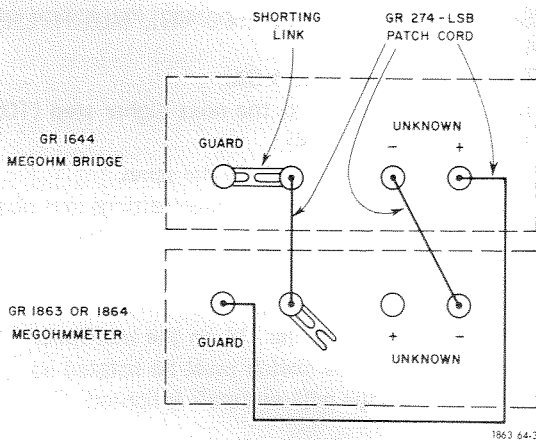

Figure 6-1. Connections for measuring standard resistors with the GR 1644 Megohm Bridge.

6.3 CABINET REMOVAL.

To remove the instrument from the cabinet, remove the two screws on the rear of the instrument cabinet and pull the instrument out of the cabinet.

WARNING

Be careful when trouble shooting the instrument when it is out of its cabinet and connected to the power line. Dangerous voltages are present, particularly at the transformer terminals. Connect the shorting link between the GUARD and ground terminals to keep the voltmeter circuitry near ground potential.

Table 6-2
STANDARD RESISTOR MEASUREMENTS

Multiplier Switch Setting	Standard Resistor Value (Ω)	Measurement Tolerance (%)
1M 100k	2 k	1
10M 1M	20 k	1
100M 10M	200 k	1
1G 100M	2 M	1
10G 1G	20 M	1
100G 10G	200 M	2
1T 100G	2 G [†]	2
10T* 1T	—	—

[†]This value only appears as a fixed resistor in the 1864. Since the value is determined by feedback multiplication of the 200-M Ω resistor in the 1863, no measurement should be made with the megohm bridge.

*This range only appears on the 1864. Its range value is determined from the feedback multiplication of the 2-G Ω resistor, therefore, no measurement should be made with the megohm bridge.

6.4 TROUBLE ANALYSIS.

6.4.1 General.

The following information is designed to assist in troubleshooting the 1863 and 1864 Megohmmeters. An understanding of the theory involved in these instruments (Section 5) makes the instrument easy to analyze because the difficulty can usually be located quickly in either the voltage regulator or in the meter circuit.

If the instrument is completely inoperative, be sure to check the power-line connection and the fuses (located on the rear panel).

6.4.2 Test Voltages.

Tables 6-3 and 6-4 list a number of typical test voltages to assist in trouble analysis. Figures 6-2 through 6-5 and the diagrams of Section 7 will assist in locating components for testing purposes.

Table 6-3
TYPE 1863 TEST VOLTAGES*

Test Point (+)	Test Point (-)	Voltage (V)
CR105 Anode	Q101 Emitter	-16.7
Q101 Collector	Q101 Emitter	20.2
Q101 Base	Q101 Emitter	0.6
Q102 Base	Q101 Emitter	20
Q102 Emitter	Q101 Emitter	21
Q103 Base	Q101 Emitter	20.5
AT23	Guard	411
CR101 Cathode	Guard	824
CR102 Cathode	Guard	419
CR103 Cathode	Guard	410
CR104 Cathode	Guard	0.6
CR201 Cathode	Guard	31
Q201 Collector	Guard	14.8
Q201 Base	Guard	0.6
AT6	Guard	9.3
AT10	Guard	8.9
Q202 Emitter	Guard	9.8
Q202 Collector	Guard	-6.5
Q203 Base	Guard	9.1
Q204 Case	Guard	0
Q204 Drain	Guard	9.2
Q204 Source	Guard	0.6
Q204 Gate	Guard	0

* Voltages are dc and the values are typical. Set TEST VOLTAGE switch to 200, function switch to CHARGE, connect the shorting link between the ground terminal and GUARD, and set the multiplier switch to 1M. Measurements made with a GR 1806 Electronic Voltmeter.

6.5 CALIBRATION PROCEDURE.

6.5.1 General.

The accuracy of the 1863 and 1864 depends on the accuracy of the range resistors, the accuracy of the applied voltages and the meter tracking accuracy. The over-all accuracy can be checked most easily by checking each one of these contributing quantities separately, for to check all points on all ranges at all voltages would require a tremendous number of measurements.

6.5.2 Meter Tracking.

The scale tracking can be easily checked using a decade resistance box with 100-k Ω and 1-M Ω steps, such as the GR 1433-H. Steps a through m of paragraph 6.2 should be performed to check the tracking. If all readings are corrected by the amount of the error at a reading of 0.5 they should be better than the specification.

Table 6-4
TYPE 1864 TEST VOLTAGES*

Test Point (+)	Test Point (-)	Voltage (V)
AT15	Q101 Emitter	24
CR105 Anode	Q101 Emitter	17.3
CR112 Anode	Q101 Emitter	18.5
Q101 Collector	Q101 Emitter	12
Q101 Base	Q101 Emitter	0.5
Q102 Base	Q101 Emitter	20
Q102 Emitter	Q101 Emitter	19.4
Q103 Base	Q101 Emitter	18.9
CR201 Cathode	AT5	36.3
Q202 Emitter	AT5	15.5
Q203 Base	AT5	14.9
CR104 Cathode	Guard	304
CR103 Cathode	Guard	613
CR102 Cathode	Guard	922
CR101 Cathode	Guard	1099
AT23	Guard	496
AT5	Guard	-6
Q201 Collector	Guard	14.7
Q201 Base	Guard	0.6
Q202 Emitter	Guard	9.5
Q204 Cathode	Guard	0
Q204 Drain	Guard	8.9
Q204 Source	Guard	0.6
Q204 Gate	Guard	0
AT6	Guard	9.2
AT10	Guard	8.7
CR201 Cathode	Guard	30.3
Q203 Base	Guard	8.9

* Voltages are dc and the values are typical. Set the TEST VOLTAGE switch to 200, function switch to CHARGE, connect the shorting link between the ground terminal and GUARD, and set the multiplier switch to 1M. Measurements made with a GR1806 Electronic Voltmeter.

6.5.3 Voltage Accuracy.

While the voltage can be checked to be within its specification, a more important check is to see that the voltage and meter sensitivity track to give a correct resistance reading. Such a check is generally adequate for it would be an unusual coincidence if both the voltage-control and meter-sensitivity resistors were both in error, such that a good reading is obtained. To check this tracking, perform steps n through s of paragraph 6.2. If a reading is incorrect, the voltages should be checked with a voltmeter, such as the GR 1806 Electronic Voltmeter, connected between the UNKNOWN + and - terminals. The function switch can be set to either the CHARGE or MEASURE positions.

If all the voltages are out of tolerance in the same direction, they can be set within the tolerance by adjusting R140 located on etched-circuit board P/N 1864-2701 (common to both the 1863 and 1864 Megohmmeters and shown in both Figures 6-2 and 6-4). The adjustment can be made as soon as the instrument is removed from the cabinet (paragraph 6.3). It is not necessary to move either of the etched-circuit boards, since the adjustment is on the top etched-circuit board. This adjustment affects all voltages by the same amount, but adjustment at 200 V minimizes possible errors due to resistance tolerances.

If all the voltages are correct but all meter readings are in error in the same direction, the meter sensitivity can be reset. Adjust R243 (Figures 6-2 and 6-4), located on the same etched-circuit board as R140, to correct the meter readings. This adjustment affects all measurements but on the 1863 is most sensitive at 200-V and 250-V and least sensitive at 100 V. In the 1864, it is most sensitive at the lower settings of the first digit of the test voltage adjustment, i.e. 100 V, 200 V, etc.

6.5.4 Range-Resistor Accuracy.

The range resistors can be checked by performing steps t through w of paragraph 6.2.

6.5.5 Coarse ∞ Adjustment.

If it is impossible to set the infinity controls on the front panel, set both controls at their center positions and adjust R244 (Figures 6-2 and 6-4), located on the etched-circuit board with R140, for a reading as close to ∞ as possible. Make the final adjustments with the front-panel controls.

6.6 KNOB REMOVAL.

If it should be necessary to remove the knob on a front-panel control, either to replace one that has been damaged or to replace the associated control, proceed as follows:

a. Grasp the knob firmly with the fingers, close into the panel (or the indicator dial, if applicable), and pull the knob straight away from the panel.

CAUTION

Do not pull on the dial to remove a dial/knob assembly. Always remove the knob first. To avoid damage to the knob and other parts of the control, do not pry the knob loose with a screwdriver or similar flat tool, and do not attempt to twist the knob from the dial.

b. Observe the position of the setscrew in the bushing, with respect to any panel markings (or at the full ccw position of a continuous control).

c. Release the setscrew and pull the bushing off the shaft.

d. Remove and retain the black nylon thrust washer, behind the dial/knob assembly, as appropriate.

NOTE

To separate the bushing from the knob, if for any reason they should be combined off the instrument, drive a machine tap a turn or two into the bushing for a sufficient grip for easy separation.

6.7 KNOB INSTALLATION.

To install a knob assembly on the control shaft:

a. Place the black nylon thrust washer over the control shaft, if appropriate.

b. Mount the bushing on the shaft, using a small slotted piece of wrapping paper as a shim for adequate panel clearance.

c. Orient the setscrew on the bushing with respect to the panel-marking index and lock the setscrew with the appropriate hex-socket key wrench.

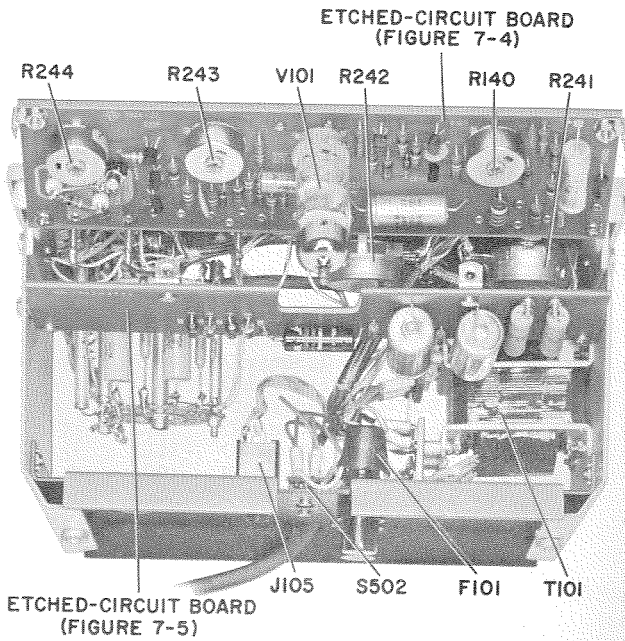

Figure 6-2. Top interior view of 1863 Megohmmeter with both etched-circuit boards tipped up.

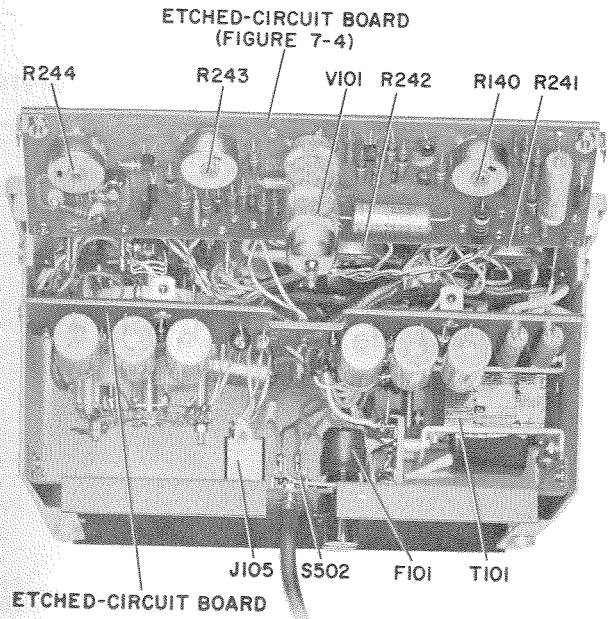

Figure 6-4. Top interior view of 1864 Megohmmeter with both etched-circuit boards tipped up.

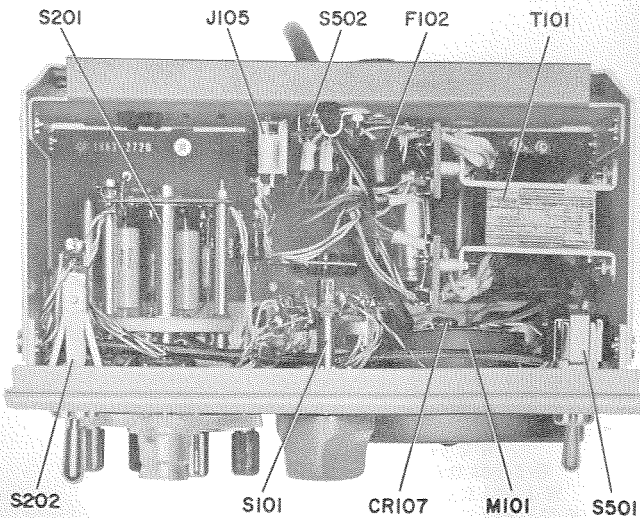

Figure 6-3. Bottom interior view of 1863 Megohmmeter.

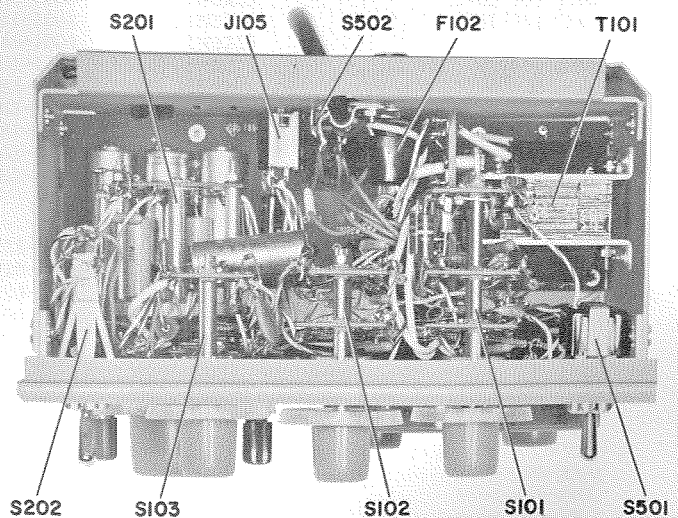

Figure 6-5. Bottom interior view of 1864 Megohmmeter.

NOTE

Make sure that the end of the shaft does not protrude through the bushing or the knob won't bottom properly.

- d. Place the knob on the bushing with the retention spring opposite the setscrew.
- e. Push the knob in until it bottoms and pull it slightly to

check that the retention spring is seated in the groove in the bushing.

NOTE

If the retention spring in the knob comes loose, reinstall it in the interior notch that has the thin slit in the side wall. It will not mount in the other notch.

Parts Lists and Diagrams—Section 7

NOTE

Asterisk indicates component peculiar to 1863.
Components without asterisk are common to both instruments or are in the 1864.

PARTS LIST

Ref. No.	Description	GR Part No.	Fed. Mfg. Code	Mfg. Part No.	Fed. Stock No.
CAPACITORS					
C101	Electrolytic, 4 μ F +150-10% 475 V	4450-2000	80183	D32845	5910-893-0879
C102	Electrolytic, 4 μ F +150-10% 475 V	4450-2000	80183	D32845	5910-893-0879
C103	Electrolytic, 4 μ F +150-10% 475 V	4450-2000	80183	D32845	5910-893-0879
C104	Electrolytic, 4 μ F +150-10% 475 V	4450-2000	80183	D32845	5910-893-0879
C105	Electrolytic, 4 μ F +150-10% 475 V	4450-2000	80183	D32845	5910-893-0879
C106	Electrolytic, 4 μ F +150-10% 475 V	4450-2000	80183	D32845	5910-893-0879
C107	Electrolytic, 25 μ F +150-80% 50 V	4450-3000	56289	D33883	5910-799-9285
C108	Ceramic, 0.01 μ F +80-20% 50 V	4401-3100	80183	CC61, 0.01 μ F +80-20%	5910-974-5697
C109	Ceramic, 100 pF +80-20% 500 V	4404-1109	72982	831, 100 pF +80-20%	
C110	Electrolytic, 0.047 μ F \pm 10% 1000 V	4860-8255	84411	663UW, 0.047 μ F \pm 10%	
C111	Ceramic, 0.1 μ F +80-20% 50 V	4403-4100	80131	CC63, 0.1 μ F +80-20%	5910-811-4788
C112	Oil Impregnated, 0.0047 μ F \pm 10% 600 V	4510-4300	56289	73P47296	5910-666-7510
C201	Electrolytic, 25 μ F +150-10% 50 V	4450-3000	56289	D33883	5910-799-9285
C202	Ceramic, 0.01 μ F +80-20% 50 V	4401-3100	80183	CC61, 0.01 μ F +80-20%	5910-974-5697
C203	Mica, 100 pF +10% 500 V	4620-1000	72136	CM15, 100 pF \pm 10%	
DIODES					
CR101	Type 1N3256	6081-1004	12672	1N3256	5960-972-9395
*CR101	Type 1N3255	6081-1003	79089	1N3255	5961-964-5242
CR102	Type 1N3256	6081-1004	12672	1N3256	5960-972-9395
*CR102	Type 1N3255	6081-1003	79089	1N3255	5961-964-5242
CR103	Type 1N3256	6081-1004	12672	1N3256	5960-972-9395
*CR103	Type 1N3255	6081-1003	79089	1N3255	5961-964-5242
CR104	Type 1N3256	6081-1004	12672	1N3256	5960-972-9395
*CR104	Type 1N3255	6081-1003	79089	1N3255	5961-964-5242
CR105	Type 1N3253	6081-1001	79089	1N3253	5961-814-4251
CR106	Type 1N3255	6081-1003	79089	1N3255	5961-964-5242
CR107	Type 1N3255	6081-1003	79089	1N3255	5961-964-5242
*CR107	Type 1N3253	6081-1003	79089	1N3255	
CR108	Type 1N3253	6081-1001	79089	1N3253	5961-814-4251
CR111	Type 1N970B 24 V	6083-1054	80211	1N970B	
CR112	Type 1N753A 6.2V	6083-1006	12672	1N753A	
CR201	Type 1N3253	6081-1001	79089	1N3253	5961-814-4251
CR211	Type 1N968B 20 V	6083-1018	80131	1N968B	5960-858-4180
CR212	Type 1N956B 15 V	6083-1047	07910	1N956B	5961-877-6192
RESISTORS					
R101	Film, 100 k Ω \pm 5% 5 W	6228-4105	14674	LP1-5, 100 k Ω \pm 5%	
R102	Film, 100 k Ω \pm 5% 5 W	6228-4105	14674	LP1-5, 100 k Ω \pm 5%	
R103	Composition, 2.2 M Ω \pm 5% 1/2 W	6100-5225	01121	RC20GF225J	5905-190-8885
R104	Composition, 2.2 M Ω \pm 5% 1/2 W	6100-5225	01121	RC20GF225J	5905-190-8885
R105	Composition, 2.2 M Ω \pm 5% 1/2 W	6100-5225	01121	RC20GF225J	5905-190-8885
R106	Composition, 2.2 M Ω \pm 5% 1/2 W	6100-5225	01121	RC20GF225J	5905-190-8885
R107	Composition, 2 k Ω \pm 5% 1/2 W	6100-2205	01121	RC20GF202J	5905-190-8887
R108	Composition, 1 k Ω \pm 5% 1/2 W	6100-2105	01121	RC20GF102J	5905-195-6806
R109	Composition, 62 k Ω \pm 5% 1 W	6110-3625	01121	RC32GF623J	5905-299-2009
*R109	Film, 100 k Ω \pm 5% 5 W	6228-4105	14674	LP1-5, 100 k Ω \pm 5%	
R110	Composition, 68 k Ω \pm 5% 1 W	6110-3685	01121	RC32GF683J	5905-299-2010
R111	Composition, 270 k Ω \pm 5% 1 W	6110-4275	01121	RC32GF274J	5905-279-4302
R112	Composition, 120 k Ω \pm 5% 1/2 W	6100-4125	01121	RC20GF124J	5905-192-3981
R113	Composition, 390 k Ω \pm 5% 1/2 W	6100-4395	01121	RC20GF394J	5905-279-2517
R114	Composition, 1.2 M Ω \pm 5% 1/2 W	6100-5125	01121	RC20GF125J	5905-190-8874
R115	Composition, 39 k Ω \pm 5% 1 W	6110-3395	01121	RC32GF393J	5905-299-2015

PARTS LIST (Cont)

Ref. No.	Description	GR Part No.	Fed. Mfg. Code	Mfg. Part No.	Fed. Stock No.
RESISTORS (cont)					
R116	Composition, 47 kΩ ±5% 2 W	6120-3475	01121	RC42GF473J	5905-190-8873
R117	Composition, 220 Ω ±5% 1/2 W	6100-1225	01121	RC20GF221J	5905-279-3513
R118	Composition, 200 kΩ ±5% 1/2 W	6100-4205	01121	RC20GF204J	5905-171-2003
R119	Composition, 12kΩ ±5% 1/2 W	6100-3125	01121	RC20GF123J	5905-279-1878
R120	Composition, 8.2kΩ ±5% 1/2 W	6100-2825	01121		5905-185-8510
R121	Composition, 10 kΩ ±5% 1/2 W	6100-3105	01121	RC20GF103J	5905-185-8510
R122	Composition, 10 kΩ ±5% 1/2 W	6100-3105	01121	RC20GF103J	5905-185-8510
R123	Film, 24.9 kΩ ±1/2% 1/8 W	6251-2249	75042	CEA-TO, 24.9 kΩ ±.5%	
R124	Film, 226 kΩ ±1/2% 1/8 W	6251-3226	75042	CEA-TO, 226 kΩ ±.5%	
*R124	Film, 249 kΩ ±1/2% 1/4 W	6351-3249	75042	CEB-TO, 249 kΩ ±.5%	
R125	Composition, 30 kΩ ±5% 1/2 W	6100-3305	01121	RC20GF303J	5905-192-3978
*R125	Film, 499 kΩ ±1/2% 1/4 W	6351-3499	75042	CEB-TO, 499 kΩ ±.5%	
R126	Film, 499 kΩ ±1/2% 1/4 W	6351-3499	75042	CEB-TO, 499 kΩ ±.5%	
*R126	Film, 249 kΩ ±1/2% 1/4 W	6351-3249	75042	CEB-TO, 249 kΩ ±.5%	
R127	Film, 1 MΩ ±1/2% 1/2 W	6451-4100	75042	CEC-TO, 1 MΩ ±.5%	
*R127	Film, 1.24 MΩ ±1/2% 1/2 W	6451-4124	75042		
R128	Film, 2 MΩ ±1/2% 1/2 W	6451-4200	75042	CEC-TO, 2 MΩ ±.5%	
R129	Film, 2 MΩ ±1/2% 1/2 W	6451-4200	75042	CEC-TO, 2 MΩ ±.5%	
R130	Film, 49.9 kΩ ±1/2% 1/4 W	6351-2499	75042	CEB-TO, 49.9 kΩ ±.5%	
R131	Film, 100 kΩ ±1% 1/4 W	6350-3100	75042	CEB, 100 kΩ ±1%	5905-539-3982
R132	Film, 200 kΩ ±1% 1/4 W	6350-3200	75042	CEB, 220 kΩ ±1%	5905-702-6528
R133	Film, 200 kΩ ±1% 1/4 W	6350-3200	75042	CEB, 220 kΩ ±1%	5905-702-6528
R134	Composition, 68 kΩ ±5% 1/2 W	6100-3685	01121	RC20GF683J	5905-249-3661
R135	Composition, 16 kΩ ±5% 1/2 W	6100-3165	01121	RC20GF163J	5905-279-3501
R136	Composition, 4.7 Ω ±5% 1/2 W	6100-9475	01121	EB, 4.7 Ω ±5%	
R137	Composition, 11Ω ±5% 1/2 W	6100-0115	01121	EB, 11Ω ±5%	
R138	Composition, 22 kΩ ±5% 1/2 W	6100-3225	01121	RC20GF223J	5905-171-2004
R139	Film, 200 kΩ ±1% 1/4 W	6350-3200	75042	CEB, 220 kΩ ±1%	5905-702-6528
*R139	Film, 208 kΩ ±1/2% 1/4 W	6351-3208	75042	CEB-TO, 208 kΩ ±.5%	
R140	Pot, Wire Wound, 5 kΩ ±10% 1/4 W	6056-0142	11236	115, 5 kΩ ±10%	
R141	Special, 30k ±5% 1/4 W	6099-3305	24655		
R201	Composition, 1.2 kΩ ±5% 1/2 W	6100-2125	01121	RC20GF122J	5905-190-8880
R202	Composition, 3.6 kΩ ±5% 1/2 W	6100-2365	01121	RC20GF352J	5905-171-2001
R203	Composition, 27 kΩ ±5% 1/2 W	6100-3275	01121	RC20GF273J	5905-279-3499
R204	Composition, 43 kΩ ±5% 1/2 W	6100-3435	01121	RC20GF433J	5905-279-3498
R205	Composition, 3.3 kΩ ±5% 1/2 W	6100-2335	01121	RC20GF332J	5905-279-3506
R206	Composition, 10 kΩ ±5% 1/2 W	6100-3105	01121	RC20GF103J	5905-185-8510
R207	Composition, 24 kΩ ±5% 1/2 W	6100-3245	01121	RC20GF243J	5905-279-1878
R208	Composition, 20 kΩ ±5% 1/2 W	6100-3205	01121	RC20GF203J	5905-192-0649
R209	Composition, 47 MΩ ±5% 1/2 W	6100-6475	01121	RC20GF476J	5905-794-3893
R210	Composition, 47 MΩ ±5% 1/2 W	6100-6475	01121	RC20GF476J	5905-794-3893
*R210	Composition, 100 MΩ ±5% 1/2 W	6100-7105	01121	EB, 100 MΩ ±5%	
R211	Film, 100 kΩ ±1% 1/8 W	6250-3100	75042	CEA, 100 kΩ ±1%	5905-577-6743
*R211	Film, 10 kΩ ±1% 1/8 W	6250-2100	75042	CEA, 10 kΩ ±1%	5905-883-4837
R212	Film, 11 kΩ ±1% 1/8 W	6250-2110	75042	CEA, 11 kΩ ±1%	5905-681-4941
*R212	Film, 1.1 kΩ ±1% 1/8 W	6250-1110	75042	CEA, 1.1 kΩ ±1%	5905-577-1791
R213	Film, 1.02 MΩ ±1% 1/2 W	6450-4102	75042	CEC, 1.02 MΩ ±1%	
*R213	Film, 102 kΩ ±1% 1/8 W	6250-3102	75042	CEA, 102 kΩ ±1%	
R214	Film, 2 kΩ ±1/2% 1/4 W	6351-1200	75042	CEB-TO, 2 kΩ ±.5%	
R215	Film, 20 kΩ ±1% 1/2 W	6450-2200	75042	CEC, 20 kΩ ±1%	
R216	Film, 200 kΩ ±1% 1 W	6550-3200	75042	MBF, 200 kΩ ±1%	5905-552-5162
R217	Film, 2 MΩ ±1% 1/2 W	6450-4200	75042	CEC, 2 MΩ ±1%	5905-539-0802
R218	Film, 20 MΩ ±1% 1 W	6550-5200	75042	MBF, 20 MΩ ±1%	
R219	Film, 200 MΩ ±1% 1 W	6619-3407	24655		
R220	Precision Carbon Coated 2 GΩ ±1% 1 W	6740-1504	63060	RX-1, 2 GΩ ±1%	
R221	Film, 1.91kΩ ±1/2% 1/4 W	6351-1191	24655		
*R221	Film, 1 kΩ ±1% 1/8 W	6250-1100	75042	CEA, 1 kΩ ±1%	5905-581-6915
R222	Film, 3.83 kΩ ±1/2% 1/4 W	6351-1383	24655		
*R222	Film, 4.99 kΩ ±1% 1/8 W	6250-1499	75042	CEA, 4.99 kΩ ±1%	
R223	Film, 7.68 kΩ ±1/2% 1/4 W	6351-1768	75042	CEB-TO, 7.68 Ω ±5%	
*R223	Film, 10 kΩ ±1% 1/8 W	6250-2100	75042	CEA, 10 kΩ ±1%	5905-883-4837
R224	Film, 7.68 kΩ ±1/2% 1/4 W	6351-1768	75042	CEB-TO, 7.68kΩ ±5%	
R225	Film, 200 Ω ±1% 1/4 W	6350-0200	75042	CEB, 200 Ω ±1%	5905-702-0028
R226	Film, 402 Ω ±1% 1/8 W	6250-0402	75042	CEA, 402 Ω ±1%	
R227	Film, 806 Ω ±1% 1/4 W	6350-0806	75042	CEB, 806 Ω ±1%	5905-815-6464
R228	Film, 806 Ω ±1% 1/4 W	6350-0806	75042	CEB, 806 Ω ±1%	5905-815-6464
R229	Composition, 1.2 kΩ ±5% 1/2 W	6100-2125	01121	RC20GF122J	5905-190-8880
*R229	Composition, 3 kΩ ±5% 1/2 W	6100-2305	01121	RC20GF302J	5905-279-1751
R230	Composition, 100 kΩ ±5% 1/2 W	6100-4105	01121	RC20GF104J	5905-195-6761
R231	Composition, 1 MΩ ±5% 1/2 W	6100-5105	01121	RC20GF105J	5905-192-0390
R232	Composition, 10 MΩ ±5% 1/2 W	6100-6105	01121	RC20GF106J	5905-279-1865
R233	Wire Wound, 470 Ω ±10% 2 W	6760-1479	75042	BWH, 470 Ω ±10%	5905-952-6772
R241	Pot, Comp. 250 Ω ±10%	6000-0100	01121	JU, 250 Ω ±10%	
*R241	Pot, Composition 50 Ω ±10%	6000-0025	01121	JU, 50 Ω ±10%	
R242	Pot, Comp. 2.5 kΩ ±10%	6000-0400	01121	53MS, 2.5 kΩ ±10%	5905-776-0400
*R243	Pot, Wire Wound, 1kΩ ±10%	6056-0138	11236		
R244	Pot, Wire Wound, 5 kΩ ±10%	6056-0142	11236	115, 5 kΩ ±10%	

PARTS LIST (Cont)

Ref. No.	Description	GR Part No.	Fed. Mfg. Code	Mfg. Part No.	Fed. Stock No.
SWITCHES					
S101	Test Voltage (1-10)	7890-5350	24655	7890-5350	
*S101	Test Voltage Switch	7890-5390	24655	7890-5390	
S102	Test Voltage (0-9)	7890-5360	24655	7890-5360	
S103	Test Voltage (V-0V)	7890-5370	24655	7890-5370	
S201	Resistance Multiplier Switch	7890-5380	24655	7890-5380	
*S201	Resistance Multiplier Switch	7890-5400	24655	7890-5400	
S202	Measure/Charge/Discharge	1864-0400	24655	1864-0400	
S501	Power OFF, toggle	7910-1300	04009	83053-SA	5930-909-3510
S502	Line Voltage Selector, slide	7910-0831	42190	4603	
TRANSISTORS					
Q101	Type 2N3905	8210-1114	93916	2N3905	
Q102	Type 2N4250	8210-1135	93916	2N4250	
*Q102	Type 2N3905	8210-1114	04713	2N3905	
Q103	Type 2N4250	8210-1135	93916	2N4250	
*Q103	Type 2N3905	8210-1114	04713	2N3905	
Q201	Type 2N3905	8210-1114	93916	2N3905	
Q202	Type 2N3903	8210-1132	04713	2N3903	
Q203	Type 2N3903	8210-1132	04713	2N3903	
Q204	Type 2N4220	8210-1143	93916	2N4220	
MISCELLANEOUS					
F101	Fuse, Slo-Blo 1/8A	5330-0450	71400	MDL, 0.125 Amp	5920-284-9455
F102	Fuse, Slo-Blo 1/16A	5330-0300	71400	MDL, 0.062 Amp	
J101	Binding Post Guard	0938-3003	24655	0938-3003	
J102	Binding Post Assy., Ground	0938-3022	24655	0938-3022	
J103	Binding Post, Unknown +	0938-3003	24655	0938-3003	
J104	Binding Post, Unknown -	0938-3003	24655	0938-3003	
J105	Output	4260-1031	82389	N111	
M101	Meter	5730-1412	24655	5730-1412	
P101	Pilot Light	5600-0300	24454	#328	6240-155-7857
P102	Pilot Light	5600-0300	24454	#328	6240-155-7857
P103	Pilot Light, Danger	5600-0316	24454	#380	
PL501	Input Power Cable	4200-1800	24655	4200-1800	5995-738-6521
T101	Transformer, Power	0345-4028	24655	0345-4028	
*T101	Transformer, Power	0345-4029	24655	0345-4029	
V101	Tube 6AB4	8360-0100	80131	6AB4	5960-262-0190
	Reg. and amplifier ass'y-1863	1864-2711	24655	1864-2711	
	Reg. and amplifier ass'y-1864	1864-2701	24655	1864-2701	

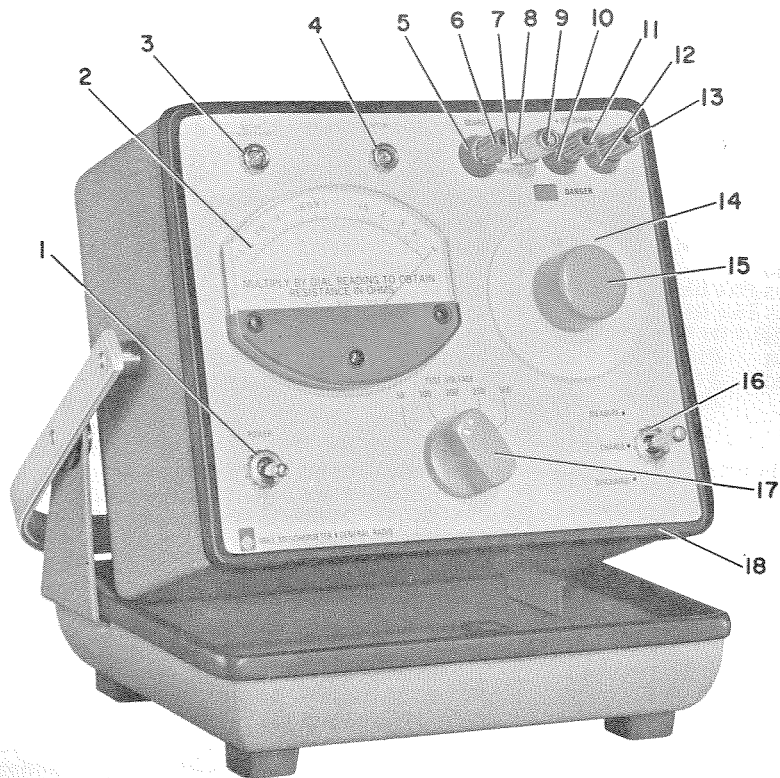

Figure 7-1. Replaceable mechanical parts on the 1863 (portable unit shown).

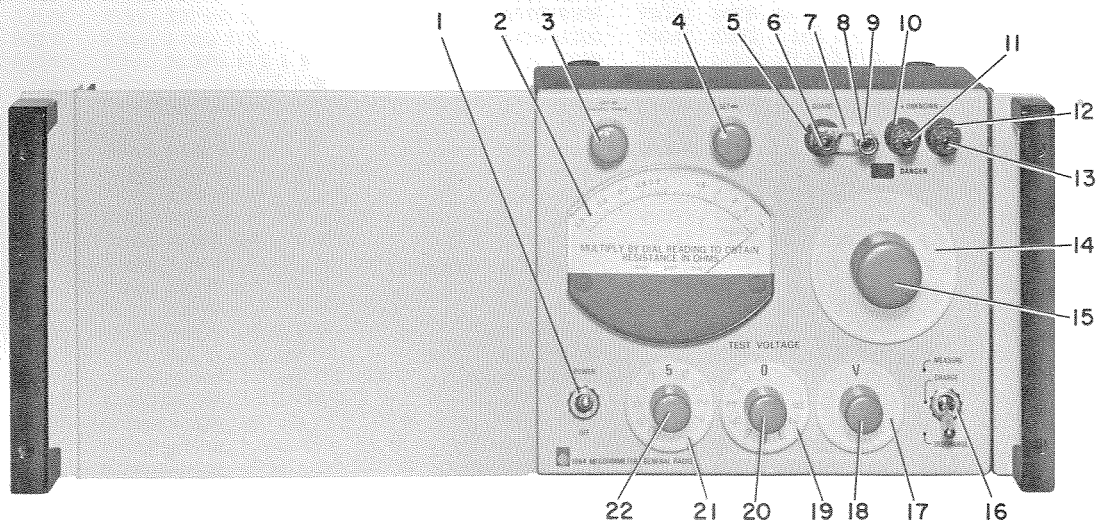
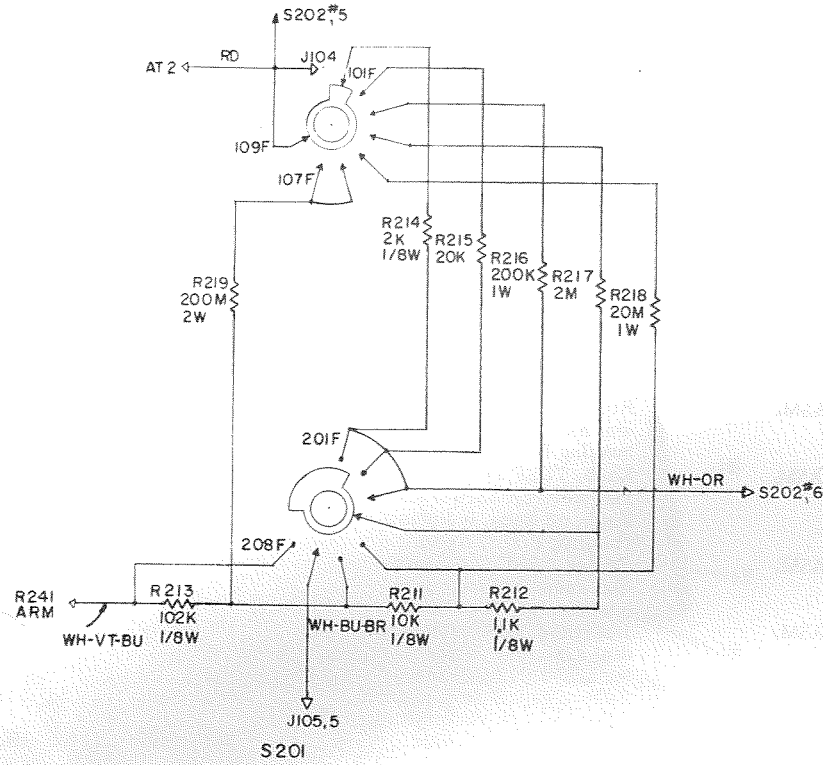

Figure 7-2. Replaceable mechanical parts on the 1864 (rack-mount unit shown).

MECHANICAL PARTS LIST

Reference Number		Name	Description	GR Part No.	Fed. Mfg. Part No.	Fed. Stock No.
Fig. 7-1	Fig. 7-2				Mfg. Code	
1	1	DRESS NUT	Nut, 15/32 -32, 7/16 inch.	5800-0800	24655 5800-0800	5310-344-3634
2	2	METER COVER	Weston, 4 inch, light gray.	5720-4711	24655 5720-4711	
3,4	—	DRESS NUT	Nut, 3/8 -32, 7/16 inch.	5800-0805	24655 5800-0805	
—	3,4	KNOB ASM.	Knob, white dot and line including retainer P/N 5220-5402.	5520-5221	24655 5520-5221	
5,10,12	5,10,12	INSULATOR	Gray insulator.	0938-9813	24655 0938-9813	
6,11,13	6,11,13	BINDING POST ASM.	Red-top. Binding Post, Brass	0938-9734	24655 0938-9734	
7	7	SHORTING LINK	Shorting link.	5080-4800	24655 5080-4800	5940-927-7452
9	8	BINDING POST ASM.	Jack with top and shaft	0938-3022	24655 0938-3022	
8	9	SPACER	Spacer to ground jack to panel.	0938-9706	24655 0938-9706	
14*	14	DIAL ASM.	Range switch dial assembly including bushing P/N 4143-3251.	1864-1200	24655 1864-1200	
15	15	KNOB	Range switch knob including retainer P/N 5220-5401.	5520-5420	24655 5520-5420	
16	16	DRESS NUT	Nut, 15/32 -32, 1/2 inch.	5800-0810	24655 5800-0810	5310-991-7185
—	17	DIAL ASM.	Right-hand TEST VOLTAGE dial assembly including bushing P/N 4143-3241.	1864-1220	24655 1864-1220	
17	—	KNOB ASM.	Knob, TEST VOLTAGE, including retainer P/N 5520-5401.	5500-5421	24655 5500-5421	
—	18,20,22	KNOB	Knob, no lines, including retainer P/N 5220-5402.	5520-5220	24655 5520-5220	
—	19	DIAL ASM.	Center TEST VOLTAGE dial assembly including bushing P/N 4143-3241.	1864-1230	24655 1864-1230	
—	21	DIAL ASM.	Left-hand TEST VOLTAGE dial assembly including bushing P/N 4143-3241.	1864-1210	24655 1864-1210	
18	—	GASKET	Rubber gasket around panel. (Removed on rack-mount unit)	5331-3602	24655 5331-3602	
Rear Panel	Rear Panel	FUSEHOLDER	Fuse Mounting Device	5650-0100	71400 HKP-H	5920-284-7144

*P/N 1863-1200 on 1863



Rotary switch sections are shown as viewed from the panel end of the shaft. The first digit of the contact number refers to the section. The section nearest the panel is 1, the next section back is 2, etc. The next two digits refer to the contact. Contact 01 is the first position clockwise from a strut screw (usually the screw above the locating key), and the other contacts are numbered sequentially (02, 03, 04, etc), proceeding clockwise around the section. A suffix F or R indicates that the contact is on the front or rear of the section, respectively.

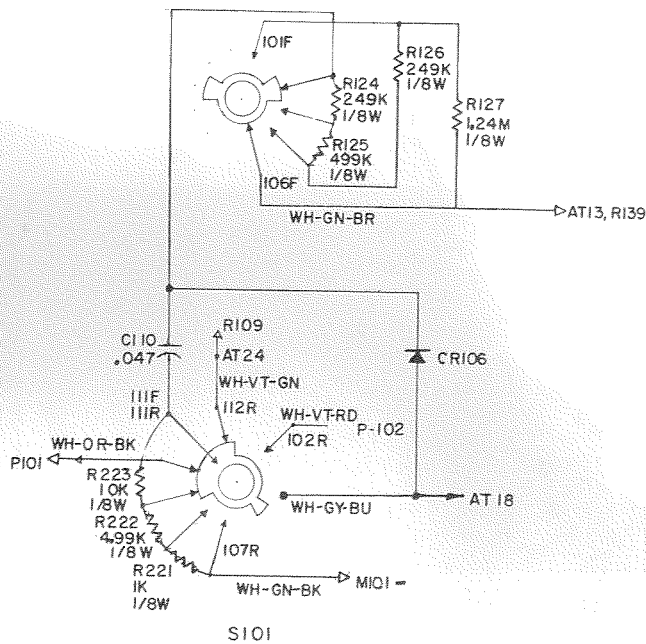

Figure 7-3. Type 1863 switching diagram.

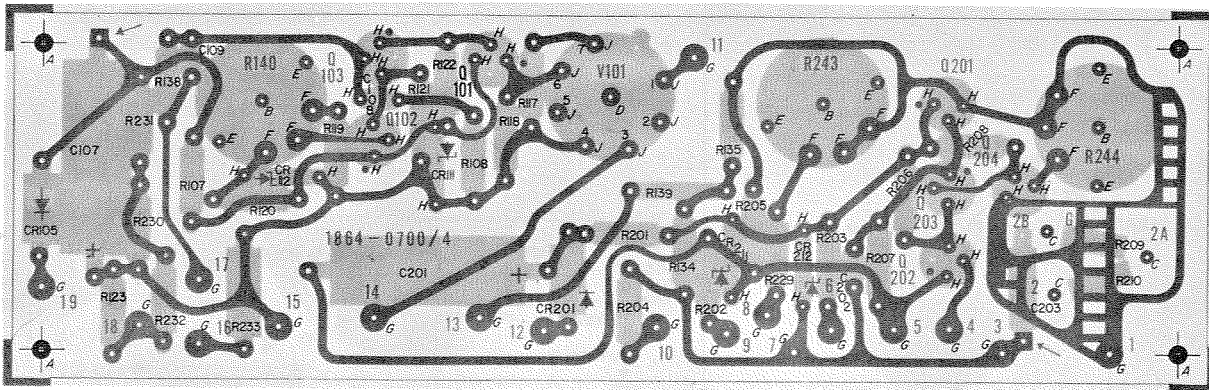

Figure 7-4. Regulator and amplifier circuits etched-board assembly for 1863 and 1864.

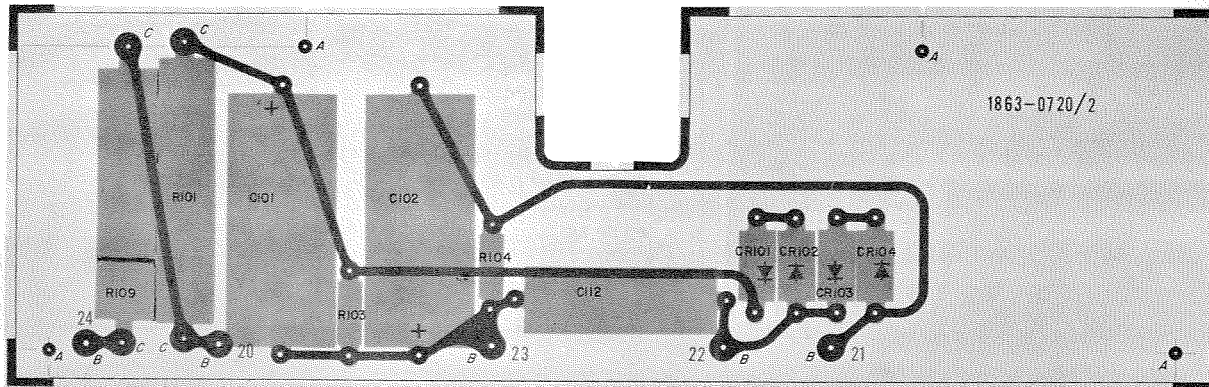
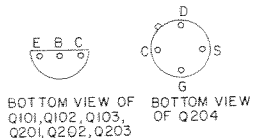
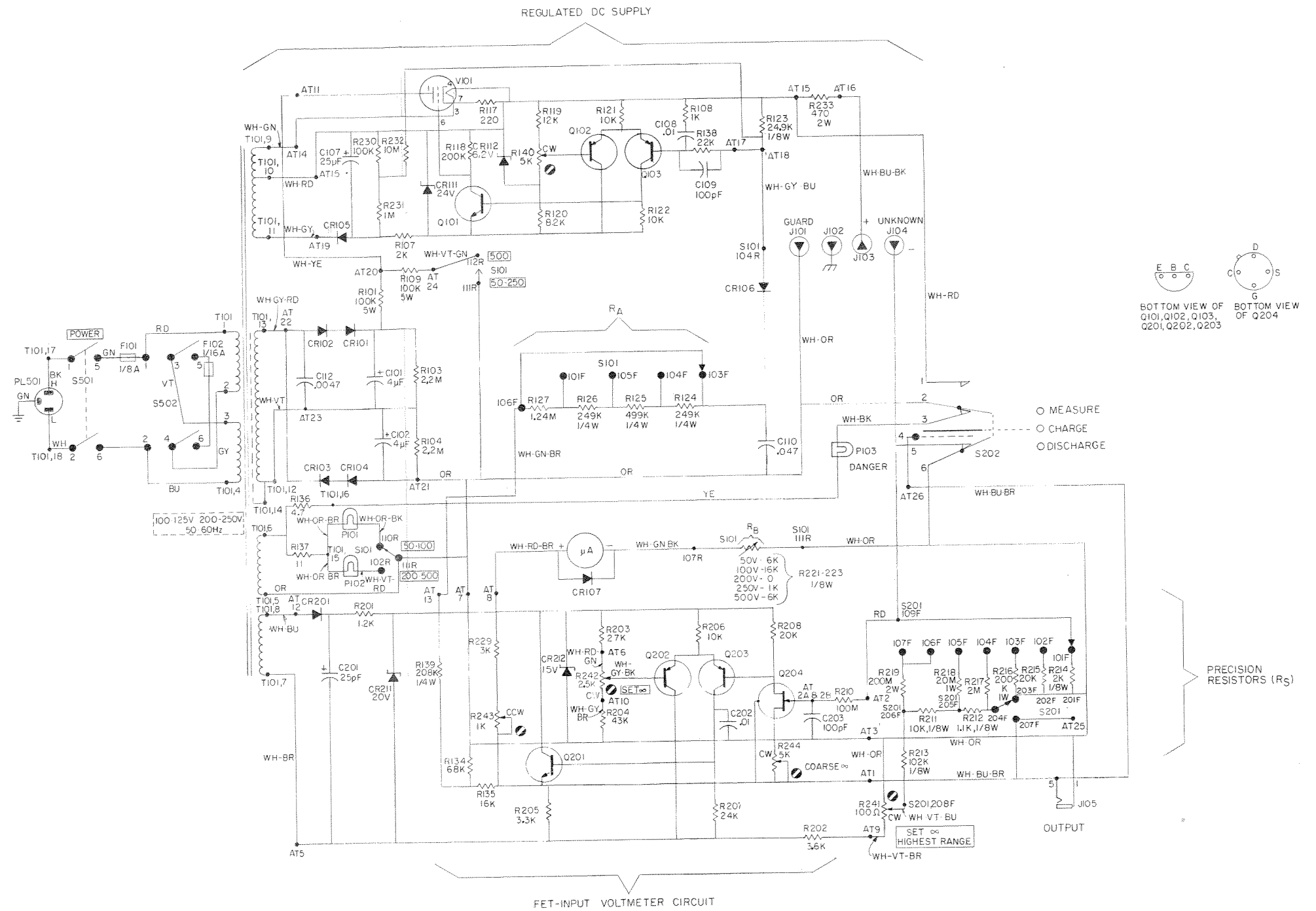

Figure 7-5. Type 1863 rectifier circuit etched-board assembly (P/N 1863-2720).

NOTE: The number appearing on the foil side is not the part number. The dot on the foil at the transistor socket indicates the collector lead.



- ANCHOR TERMINALS USED AT 1, 2, 2A, 2B, 3 THRU 26
NOTE UNLESS SPECIFIED
- | | |
|--|---|
| 1. POSITION OF ROTARY SWITCHES SHOWN COUNTERCLOCKWISE. | 5. RESISTANCE IN OHMS
K - 1000 OHMS M - 1 MEGOHM |
| 2. CONTACT NUMBERING OF SWITCHES EXPLAINED ON SEPARATE SHEET SUPPLIED IN INSTRUCTION BOOK. | 6. CAPACITANCE VALUES ONE AND OVER IN PICOFARADS, LESS THAN ONE IN MICROFARADS. |
| 3. REFER TO SERVICE NOTES IN INSTRUCTION BOOK FOR VOLTAGES APPEARING ON DIAGRAM. | 7. KNOB CONTROL |
| 4. RESISTORS 1/2 WATT. | 8. SCREWDRIVER CONTROL |
| | 9. AT - ANCHOR TERMINAL |
| | 10. TP - TEST POINT |

Figure 7-6. Type 1863 schematic diagram.

FEDERAL MANUFACTURER'S CODE

From Federal Supply Code for Manufacturers Cataloging Handbooks H4-1 (Name to Code) and H4-2 (Code to Name) as supplemented through August, 1968.

Code	Manufacturer	Code	Manufacturer	Code	Manufacturer
00192	Jones Mfg. Co, Chicago, Illinois	49671	RCA, New York, N.Y. 10020	80431	Air Filter Corp, Milwaukee, Wisc. 53218
00194	Walsco Electronics Corp, L.A., Calif.	49956	Raytheon Mfg Co, Waltham, Mass. 02154	80583	Hammarlund Co, Inc, New York, N.Y.
00434	Schweber Electronics, Westburg, L.I., N.Y.	53021	Sangamo Electric Co, Springfield, Ill. 62705	80740	Beckman Instruments, Inc, Fullerton, Calif.
00656	Aerovox Corp, New Bedford, Mass.	54294	Shallicross Mfg Co, Selma, N.C.	81030	International Instrument, Orange, Conn.
01009	Aiden Products Co, Brockton, Mass.	54715	Shure Brothers, Inc, Evanston, Ill.	81073	Grayhill Inc, LaGrange, Ill. 60525
01121	Allen-Bradley, Co, Milwaukee, Wisc.	56289	Sprague Electric Co, N. Adams, Mass.	81143	Isolantite Mfg Corp, Stirling, N.J. 07980
01295	Texas Instruments, Inc, Dallas, Texas	59730	Thomas and Betts Co, Elizabeth, N.J. 07207	81349	Military Specifications
02114	Ferrocube Corp, Saugerties, N.Y. 12477	59875	TRW Inc, (Accessories Div), Cleveland, Ohio	81350	Joint Army-Navy Specifications
02606	Fenwal Lab Inc, Morton Grove, Ill.	60399	Torrington Mfg Co, Torrington, Conn.	81751	Columbus Electronics Corp, Yonkers, N.Y.
02660	Amphenol Electron Corp, Broadview, Ill.	61637	Union Carbide Corp, New York, N.Y. 10017	81831	Filtron Co, Flushing, L.I., N.Y. 11354
02768	Fastax, Des Plaines, Ill. 60016	61864	United-Carr Fastener Corp, Boston, Mass.	81840	Ledex Inc, Dayton, Ohio 45402
03508	G.E. Semicon Prod, Syracuse, N.Y. 13201	63060	Victoreen Instrument Co, Inc, Cleveland, O.	81860	Barry-Wright Corp, Watertown, Mass.
03636	Grayburne, Yonkers, N.Y. 10701	63743	Ward Leonard Electric Co, Mt. Vernon, N.Y.	82219	Sylvania Elec Prod, Emporium, Penn.
03888	Pyrofilm Resistor Co, Cedar Knolls, N.J.	65083	Westinghouse (Lamp Div), Bloomfield, N.J.	82273	Indiana Pattern & Model Works, LaPort, Ind.
03911	Clairex Corp, New York, N.Y. 10001	65092	Weston Instruments, Newark, N.J.	82389	Switchcraft Inc, Chicago, Ill. 60630
04009	Arrow-Hart & Hegeman, Hartford, Conn. 06106	70485	Atlantic-India Rubber, Chicago, Ill. 60607	82647	Metals & Controls Inc, Attleboro, Mass.
04713	Motorola, Phoenix, Ariz. 85008	70563	Amperite Co, Union City, N.J. 07087	82807	Milwaukee Resistor Co, Milwaukee, Wisc.
05170	Eng'rd Electronics, Santa Ana, Calif. 92702	70903	Belden Mfg Co, Chicago, Ill. 60644	83033	Meissner Mfg, (Maguire Ind) Mt. Carmel, Ill.
05624	Barber-Colman Co, Rockford, Ill. 61101	71126	Bronson, Homer D, Co, Beacon Falls, Conn.	83058	Carr Fastener Co, Cambridge, Mass.
05820	Wakefield Eng, Inc, Wakefield, Mass. 01880	71294	Canfield, H.O. Co, Clifton Forge, Va. 24422	83186	Victory Engineering, Springfield, N.J. 07081
07126	Digitron Co, Pasadena, Calif.	71400	Bussman (McGraw Edison), St. Louis, Mo.	83361	Bearing Specialty Co, San Francisco, Calif.
07127	Eagle Signal (E.W. Bliss Co), Baraboo, Wisc.	71468	ITT Cannon Elec, L.A., Calif. 90031	83587	Solar Electric Corp, Warren, Penn.
07261	Avnet Corp, Culver City, Calif. 90230	71590	Centralab, Inc, Milwaukee, Wisc. 53212	83740	Union Carbide Corp, New York, N.Y. 10017
07263	Fairchild Camera, Mountain View, Calif.	71666	Continental Carbon Co, Inc, New York, N.Y.	83781	National Electronics Inc, Geneva, Ill.
07387	Birtcher Corp, No. Los Angeles, Calif.	71707	Coto Coil Co Inc, Providence, R.I.	84411	TRW Capacitor Div, Ogallala, Nebr.
07595	Amer Semicond, Arlington Hts, Ill. 60004	71744	Chicago Miniature Lamp Works, Chicago, Ill.	84835	Lahigh Metal Prods, Cambridge, Mass. 02140
07828	Bodine Corp, Bridgeport, Conn. 06605	71785	Cinch Mfg Co, Chicago, Ill. 60624	84971	TA Mfg Corp, Los Angeles, Calif.
07829	Bodine Electric Co, Chicago, Ill. 60618	71823	Darnell Corp, Ltd, Downey, Calif. 90241	86577	Precision Metal Prods, Stoneham, Mass. 02180
07910	Cont Device Corp, Hawthorne, Calif.	72136	Electro Motive Mfg Co, Wilmington, Conn.	86684	RCA (Elect. Comp & Dev), Harrison, N.J.
07983	State Labs Inc, N.Y., N.Y. 10003	72259	Nytronics Inc, Berkeley Heights, N.J. 07922	86687	REC Corp, New Rochelle, N.Y. 10801
07999	Borg Inst., Delavan, Wisc. 53115	72619	Dialight Co, Brooklyn, N.Y. 11237	86800	Cont Electronics Corp, Brooklyn, N.Y. 11222
08730	Vemaline Prod Co, Franklin Lakes, N.J.	72699	General Instr Corp, Newark, N.J. 07104	88140	Cutler-Hammer Inc, Lincoln, Ill.
09213	G.E. Semiconductor, Buffalo, N.Y.	72765	Drake Mfg Co, Chicago, Ill. 60656	88219	Gould Nat. Batteries Inc, Trenton, N.J.
09408	Star-Tronics Inc, Georgetown, Mass. 01830	72825	Hugh H. Eby Inc, Philadelphia, Penn. 19144	88419	Cornell-Dubilier, Fuquay-Varina, N.C.
09823	Burgess Battery Co, Freeport, Ill.	72962	Elastic Stop Nut Corp, Union, N.J. 07083	88627	K & G Mfg Co, New York, N.Y.
09922	Burndy Corp, Norwalk, Conn. 06852	72982	Erie Technological Products Inc, Erie, Penn.	89482	Holtzer-Cabot Corp, Boston, Mass.
11236	C.T.S. of Berne, Inc, Berne, Ind. 46711	73138	Beckman Inc, Fullerton, Calif. 92634	89665	United Transformer Co, Chicago, Ill.
11599	Chandler Evans Corp, W. Hartford, Conn.	73445	Amperex Electronics Co, Hicksville, N.Y.	90201	Mallory Capacitor Co, Indianapolis, Ind.
12040	National Semiconductor, Danbury, Conn.	73559	Carling Electric Co, W.Hartford, Conn.	90750	Westinghouse Electric Corp, Boston, Mass.
12498	Crystalonics, Cambridge, Mass. 02140	73690	Elco Resistor Co, New York, N.Y.	90952	Hardware Products Co, Reading, Penn. 19602
12672	RCA, Woodbridge, N.J.	73899	JFD Electronics Corp, Brooklyn, N.Y.	91032	Continental Wire Corp, York, Penn. 17405
12697	Clarostat Mfg Co, Inc, Dover, N.H. 03820	74193	Heinemann Electric Co, Trenton, N.J.	91146	ITT (Cannon Electric Inc), Salem, Mass.
12954	Dickson Electronics, Scottsdale, Ariz.	74861	Industrial Condenser Corp, Chicago, Ill.	91293	Johanson Mfg Co, Boonton, N.J. 07005
13327	Solltron Devices, Tappan, N.Y. 10983	74970	E.F. Johnson Co, Waseca, Minn. 56093	91506	Augat Inc, Attleboro, Mass. 02703
14433	ITT Semiconductors, W.Palm Beach, Fla.	75042	IRC Inc, Philadelphia, Penn. 19108	91598	Chandler Co, Wethersfield, Conn. 06109
14655	Cornell-Dubilier Electric Co, Newark, N.J.	75382	Kulka Electric Corp, Mt. Vernon, N.Y.	91637	Dale Electronics Inc, Columbus, Nebr.
14674	Corning Glass Works, Corning, N.Y.	75491	Lafayette Industrial Electronics, Jamaica, N.Y.	91662	Elco Corp, Willow Grove, Penn.
14936	General Instrument Corp, Hicksville, N.Y.	75608	Linden and Co, Providence, R.I.	91719	General Instruments, Inc, Dallas, Texas
15238	ITT, Semiconductor Div, Lawrence, Mass.	75915	Littelfuse, Inc, Des Plaines, Ill. 60016	91929	Honeywell Inc, Freeport, Ill.
15605	Cutler-Hammer Inc, Milwaukee, Wisc. 53233	76005	Lord Mfg Co, Erie, Penn. 16512	92519	Electra Insul Corp, Woodside, L.I., N.Y.
16037	Spruce Pine Mica Co, Spruce Pine, N.C.	76149	Mallory Electric Corp, Detroit, Mich. 48204	92678	E.G.&G., Boston, Mass.
17771	Singer Co, Diehl Div, Somerville, N.J.	76487	James Millen Mfg Co, Malden, Mass. 02148	93332	Sylvania Elect Prods, Inc, Woburn, Mass.
19396	Illinois Tool Works, Pakton Div, Chicago, Ill.	76545	Mueller Electric Co, Cleveland, Ohio 44114	93916	Cramer Products Co, New York, N.Y. 10013
19644	LRC Electronics, Horseheads, N.Y.	76684	National Tube Co, Pittsburg, Penn.	94144	Raytheon Co, Components Div, Quincy, Mass.
19701	Electra Mfg Co, Independence, Kansas 67301	76854	Oak Mfg Co, Crystal Lake, Ill.	94154	Tung Sol Electric Inc, Newark, N.J.
21335	Fafnir Bearing Co, New Briton, Conn.	77147	Patton MacGuey Co, Providence, R.I.	95076	Garde Mfg Co, Cumberland, R.I.
22753	UID Electronics Corp, Hollywood, Fla.	77166	Pass-Seymour, Syracuse, N.Y.	95121	Quality Components Inc, St. Mary's, Penn.
23342	Avnet Electronics Corp, Franklin Park, Ill.	77263	Pierce Roberts Rubber Co, Trenton, N.J.	95146	Alco Electronics Mfg Co, Lawrence, Mass.
24446	G.E., Schenectady, N.Y. 12305	77339	Positive Lockwasher Co, Newark, N.J.	95238	Continental Connector Corp, Woodside, N.Y.
24454	G.E., Electronics Comp, Syracuse, N.Y.	77542	Ray-O-Vac Co, Madison, Wisc.	95275	Vitramon, Inc, Bridgeport, Conn.
24455	G.E. (Lamp Div), Nela Park, Cleveland, Ohio	77630	TRW, Electronic Comp, Camden, N.J. 08103	95354	Methode Mfg Co, Chicago, Ill.
24655	General Radio Co, W. Concord, Mass. 01781	77638	General Instruments Corp, Brooklyn, N.Y.	95412	General Electric Co, Schenectady, N.Y.
26806	American Zettlet Inc, Costa Mesa, Calif.	78189	Shakeproof (Ill. Tool Works), Elgin, Ill. 60120	95794	Aneconda Amer Brass Co, Torrington, Conn.
28520	Hayman Mfg Co, Kenilworth, N.J.	78277	Sigma Instruments Inc, S.Braintree, Mass.	96095	Hi-Q Div. of Aerovox Corp, Orlan, N.Y.
28959	Hoffman Electronics Corp, El Monte, Calif.	78488	Stackpole Carbon Co, St. Marys, Penn.	96214	Texas Instruments Inc, Dallas, Texas 75209
30874	I.B.M. Armonk, New York	78553	Tinnerman Products, Inc, Cleveland, Ohio	96256	Thordaron-Meissner, Mt. Carmel, Ill.
32001	Jensen Mfg. Co, Chicago, Ill. 60638	79089	RCA, Rec Tube & Semicond, Harrison, N.J.	96341	Microwave Associates Inc, Burlington, Mass.
33173	G.E. Comp, Owensboro, Ky. 42301	79725	Wiremold Co, Hartford, Conn. 06110	96791	Amphenol Corp, Jonesville, Wisc. 53545
35929	Constanta Co, Mont. 19, Qua.	79963	Zierlick Mfg Co, New Rochelle, N.Y.	96906	Military Standards
37942	P.R. Mallory & Co Inc, Indianapolis, Ind.	80030	Prestole Fastener, Toledo, Ohio	98291	Sealectro Corp, Mamaroneck, N.Y. 10544
38443	Marlin-Rockwell Corp, Jamestown, N.Y.	80048	Vickers Inc, St. Louis, Mo.	98474	Compar Inc, Burlingame, Calif.
40931	Honeywell Inc, Minneapolis, Minn. 55408	80131	Electronic Industries Assoc, Washington, D.C.	98821	North Hills Electronics Inc, Glen Cove, N.Y.
42190	Muter Co, Chicago, Ill. 60638	80183	Sprague Products Co, No. Adams, Mass.	99180	Transitron Electronics Corp, Melrose, Mass.
42498	National Co, Inc, Melrose, Mass. 02176	80211	Motorola Inc, Franklin Park, Ill. 60131	99313	Varian, Palo Alto, Calif. 94303
43991	Norma-Hoffman, Stanford, Conn. 06904	80258	Standard Oil Co, Lafayette, Ind.	99378	Atlee Corp, Winchester, Mass. 01890
		80294	Bourns Inc, Riverside, Calif. 92506	99800	Delevan Electronics Corp, E. Aurora, N.Y.

Rotary switch sections are shown as viewed from the panel end of the shaft. The first digit of the contact number refers to the section. The section nearest the panel is 1, the next section back is 2, etc. The next two digits refer to the contact. Contact 01 is the first position clockwise from a strut screw (usually the screw above the locating key), and the other contacts are numbered sequentially (02, 03, 04, etc), proceeding clockwise around the section. A suffix F or R indicates that the contact is on the front or rear of the section, respectively.

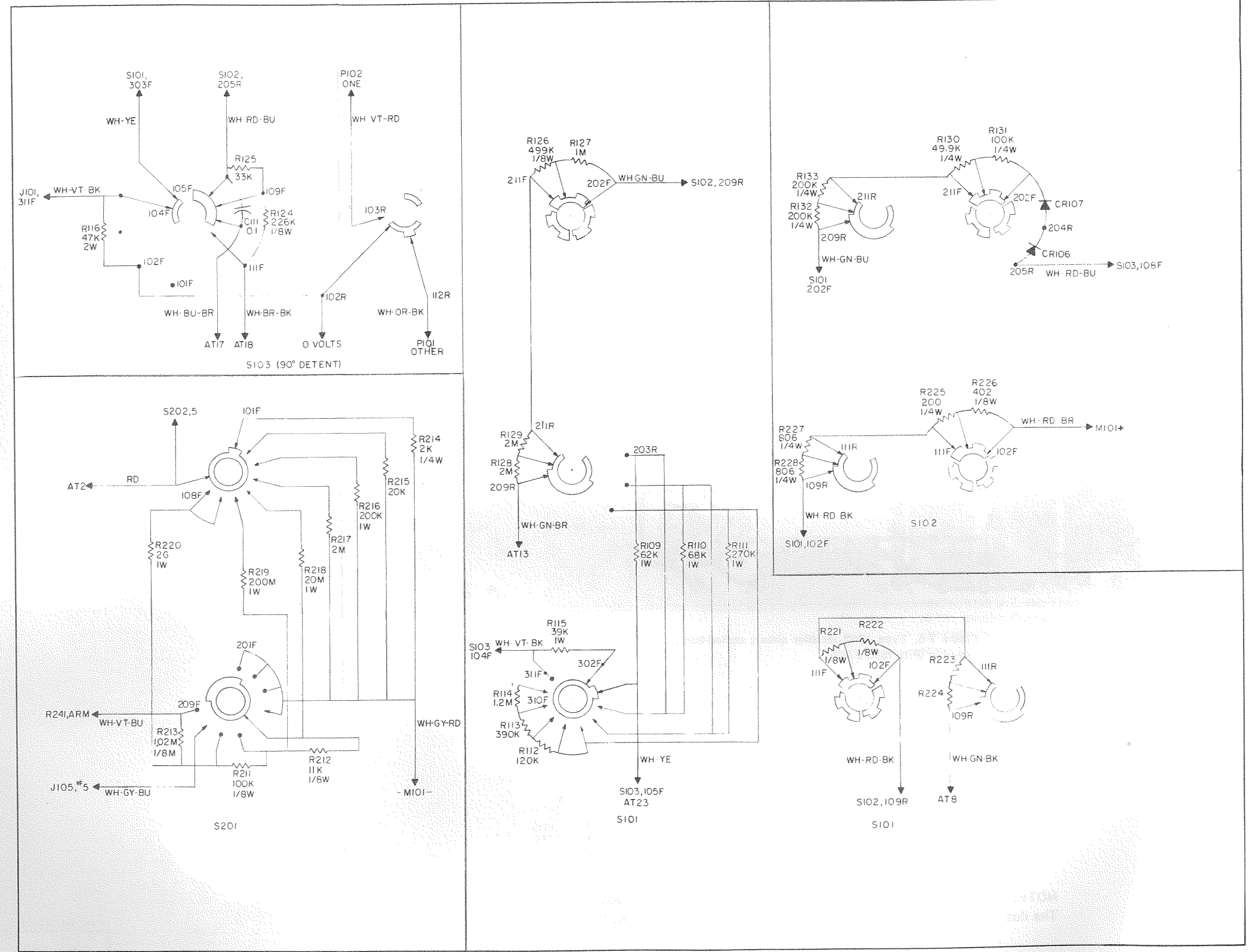

Figure 7-7. Type 1864 switching diagram.

Visc. 53218
 ork, N.Y.
 ullerton, Calif.
 ange, Conn.
 0525
 N.J. 07980
 ons
 Yonkers, N.Y.
 Y. 11354
 402
 n, Mass.
 m, Penn.
 rks, LaPort, Ind.
 60630
 ooro, Mass.
 auaukee, Wisc.
 Mt. Carmel, Ill.
 , Mass.
 eld, N.J. 07081
 anisco, Calif.
 Penn.
 ork, N.Y. 10017
 neva, Ill.
 , Nebr.
 dge, Mass. 02140
 Calif.
 ham, Mass. 02180
 Harrison, N.J.
 Y. 10801
 oklyn, N.Y. 11222
 Ill.
 enton, N.J.
 rlna, N.C.
 .Y.
 . Mass.
 cago, Ill.
 napolis, Ind.
 Boston, Mass.
 ing, Penn. 19602
 x, Penn. 17405
 Salem, Mass.
 N.J. 07005
 02703
 Conn. 06109
 bus, Nebr.
 nn.
 allas, Texas
 e, L.I., N.Y.
 oburn, Mass.
 ork, N.Y. 10013
 Div, Quincy, Mass.
 rk, N.J.
 R.I.
 . Mary's, Penn.
 wrence, Mass.
 o, Woodside, N.Y.
 Conn.
 Ill.
 ctady, N.Y.
 Torrington, Conn.
 Orlean, N.Y.
 as, Texas 75209
 armel, Ill.
 Burlington, Mass.
 Wisc. 53545
 k, N.Y. 10544
 Cliff.
 Glen Cove, N.Y.
 o, Melrose, Mass.
 303
 ss. 01890
 E. Aurora, N.Y.

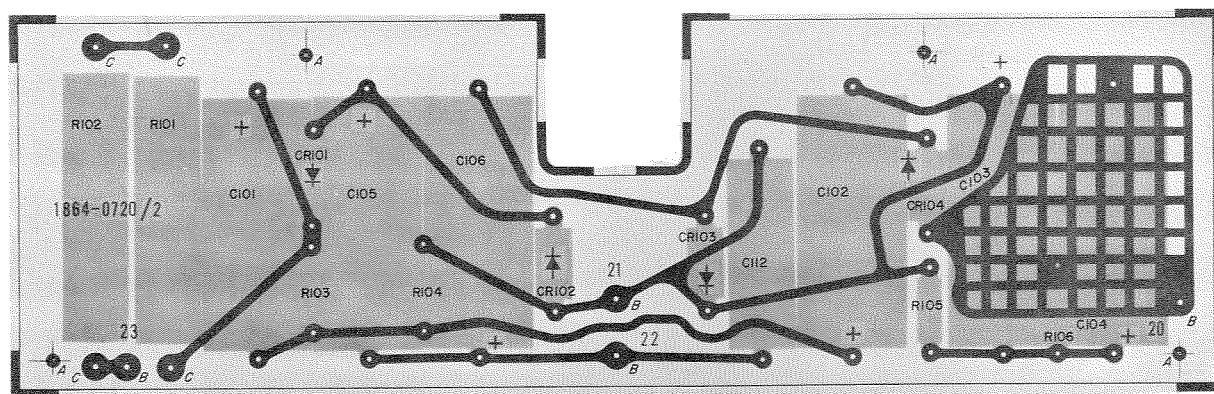

Figure 7-8. Type 1864 rectifier circuit etched-board assembly (P/N 1864-2720).

NOTE: The number appearing on the foil side is not the part number. The dot on the foil at the transistor socket indicates the collector lead.

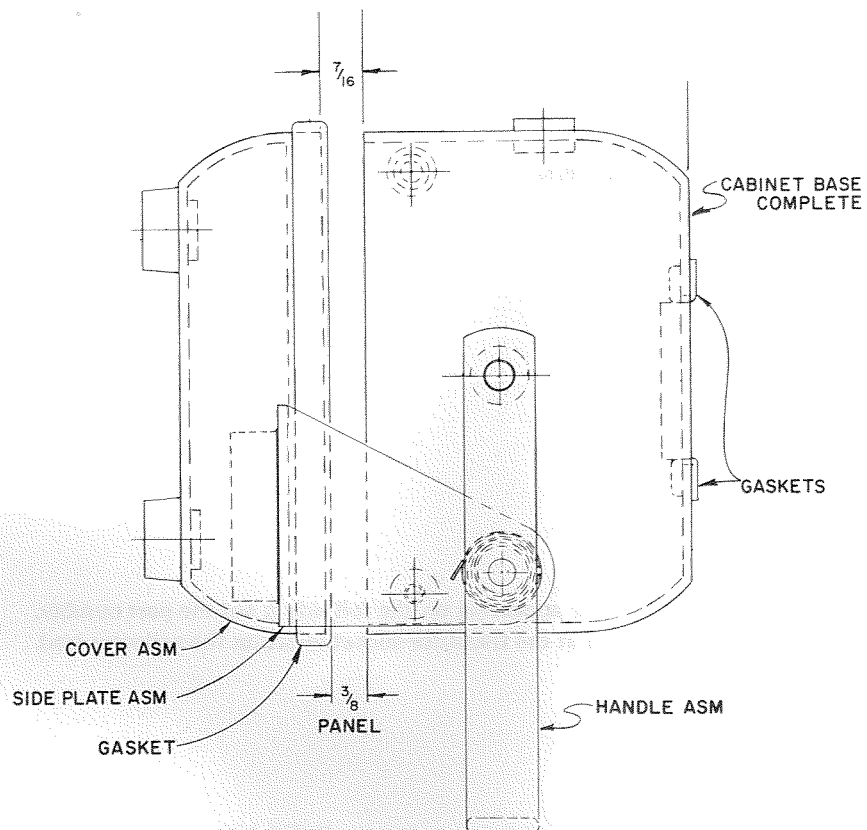
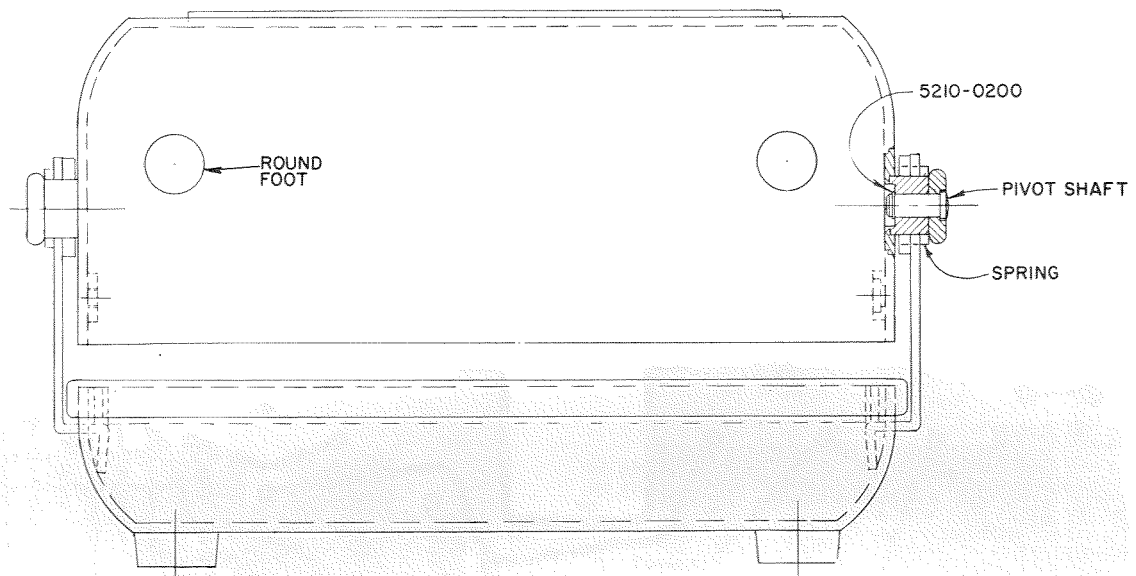
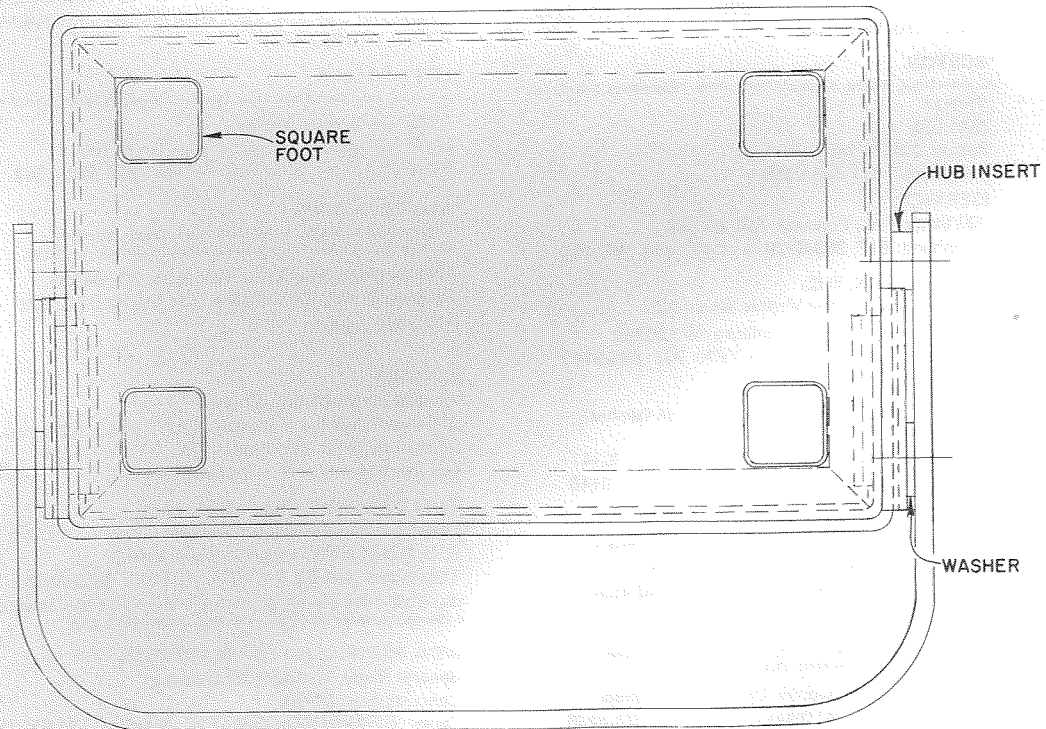

Figure 7-10. Complete cabinet assembly (P/N 4182-2328).

<i>Name</i>	<i>GR Part Number</i>
Cabinet Base Complete	4182-1328
Cover Assembly	4182-1425
Handle Assembly	4182-1503
Gasket, base (2 required)	5168-3620
Gasket, cover	5168-3605
Foot, round (2 required)	5260-2051
Foot, square (4 required)	5260-2060
Hub Insert	4182-6010
Side Plate Assembly*	
Left	4182-1455
Right	4182-1475
Washer rubber* (2 required)	8030-1642
Spring*	4182-8000
Pivot Shaft* (2 required)	4182-6000
External Fastener Ring* (2 required)	5210-0200

*Part of Hardware Set 4182-3010.





General Radio

300 BAKER AVENUE, CONCORD, MASSACHUSETTS 01742

*NEW YORK

Delaware, New Jersey, New York, Eastern Pennsylvania
380 Midland Avenue, Saddle Brook, NJ 07662
Telephone: (NJ) 201 791-8990 (NY) 212 964-2722
TWX: 710 988-2205

*BOSTON

Connecticut, Maine, Massachusetts, New Hampshire, Rhode Island,
Vermont

(SALES)

Bolton, MA 01740
Telephone: 617 646-0550

(SERVICE)

300 Baker Ave., Concord, MA 01742
Telephone: 617 369-8770 • TWX: 710 347-1051

*WASHINGTON, D.C.

Maryland, Virginia, West Virginia, (Wash. D.C.)
15 Firstfield Road, Gaithersburg, MD 20760
Telephone: 301 948-7071 • TWX: 710 828-9741

ATLANTA

Alabama, Florida, Georgia, Mississippi, North Carolina,
South Carolina, Tennessee
7 Dunwoody Park, Suite 115, Atlanta, GA 30341
Telephone: 404 457-2485, (FLA) 813 531-0148

DAYTON

Kentucky, Indiana, Michigan, Ohio, Western Pennsylvania
3300 S. Dixie Drive, Dayton, OH 45439
Telephone: 513 294-1500 • TWX: 810-459-1785

*CHICAGO

Illinois, Iowa, Kansas, Minnesota, Missouri, Nebraska,
North Dakota, South Dakota, Wisconsin
9440 West Foster Avenue, Chicago, IL 60656
Telephone: 312 992-0800 • TWX: 910 221-5486

*DALLAS

Arkansas, Colorado, Louisiana, New Mexico, Oklahoma, Texas, Wyoming
777 So. Central Expressway, Suite 1-D, Richardson, TX 75080
Telephone: 214 234-3357, (HOUSTON) 713 464-5112
• TWX: 910 867-4771

*LOS ANGELES

Arizona, Southern California, Hawaii, Nevada (Clark County only)
17361 Armstrong Avenue
Irvine Industrial Complex, Irvine, CA 92705
Telephone: 714 540-9830 • TWX: 910 595-1762

*SAN FRANCISCO

Northern California, British Columbia, Idaho, Montana,
Nevada (except Clark County), Oregon, Washington, Utah
1050 East Meadow Circle, Palo Alto, CA 94303
Telephone: 415 948-8233 • TWX: 910 373-1203
Alaska 907 279-5741

CANADA

*General Radio Canada Limited

307 Evans Avenue, Toronto, Ontario M8Z 1K2
Telephone: 416 252-3395 • TELEX: 02-29294
Montreal 514 737-2126 • Ottawa 613 233-4237

EUROPE, AFRICA, and NEAR EAST

*General Radio Company (Overseas)

P. O. Box, CH-8034 Zurich, Switzerland
Telephone: (01) 55 24 20 • TELEX: 845-53638

*Paris 355 7546 • Lyon 28 01 45 • *Milan 29 31 29 • *Munich 40 18 01
• Hamburg 45 06 56 • *Bourne End (England) 22567

*ASIA, PACIFIC, and LATIN AMERICA

General Radio International Division
Concord, Mass 01742
Cable: GENRADCO CONCORD (Mass) • TELEX: 094-594

GR COMPANIES • Grason-Stadler • Time/Data • Techware Computing Corp. GR ASSOCIATE • Micronetic Systems, Inc.

*Service Facilities

Printed in USA

GENERAL RADIO
WEST CONCORD, MASSACHUSETTS 01781